

# ME - 4141

## Instruções de Montagem Assembly Instructions Instrucciones de Armado WWW.MUEBLES2020.COM

**MUEBLES 2020**  
Fácil Armado

Carrera 15 # 110-71-Barrio Santa Paula  
Celular 3182000653/ Teléfono: 4660694

### Notas Especiais:

**01** - Examine completamente todas as peças do móvel antes de começar o trabalho.

**02** - Recomenda-se montar o móvel conforme este Manual de Montagem.

**03** - É de responsabilidade do montador seguir as instruções do Manual de Montagem, que são fundamentais para garantir a estrutura do móvel.

**04** - Para limpeza, utilizar somente pano úmido e sabão neutro.

### Special notes:

**01** - Check all parts of the unit thoroughly before starting work.

**02** - It is recommended to assemble the furniture according to this Installation Manual.

**03** - It is the responsibility of the assembler to follow the instructions in the Assembly Manual, which are essential to ensure the structure of the furniture.

**04** - For cleaning use only damp cloth and neutral soap.

### Notas especiales:

**01** - Examine completamente todas las piezas del mueble antes de iniciar el trabajo.

**02** - Se recomienda montar el mueble conforme el Manual de Ensamblaje.

**03** - Es de responsabilidad del montador seguir las instrucciones del Manual de Ensamblaje, que son fundamentales para garantizar la estructura del mueble.

**04** - Para limpieza solamente usar trapo húmedo y jabón neutro.

### Garante certificate:

Garantia de 12 meses por defectos de fábrica. Se recomienda que este producto sea armado por un experto.

### Ferramentas | Tools | Herramientas

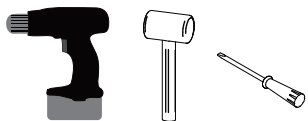







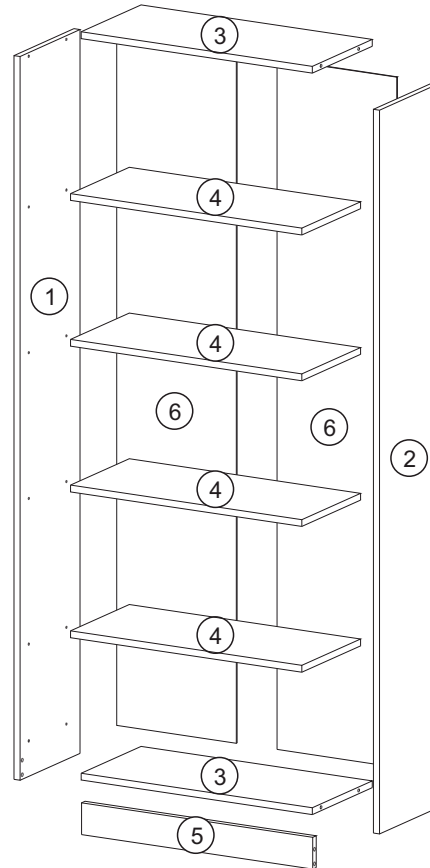

45 min.



### Lista de Peças / List of pieces / Lista de piezas

CÓD	DESCRIÇÃO	DESCRIPTION	DESCRIPCIÓN	QTD	RAW MATERIAL	DIMENSION
01	Lateral Esquerda	Left Side	Lateral Izquierda	1	MDP 15mm	1594x255x15
02	Lateral Direita	Right Side	Lateral Derecha	1	MDP 15mm	1594x255x15
03	Base	Base	Base	2	MDP 15mm	568x255x15
04	Prateleira Móvel	Mobile Shelf	Estante Mobile	4	MDP 15mm	568x250x15
05	Rodapé	Footer	Pie	1	MDP 15mm	568x70x15
06	Costa	Back	Revés	2	Chapa Dura 3mm	1520x290x3



REF	DESCRIÇÃO	QTD
A	 8x30mm	04
B	 34x7mm Parafuso Minifix	08
C	 15x12mm Tambor Minifix	08
D	 14x8x5mm Suporte Prateleira 5x8 c/ Estria	16
E	 22x3mm Prego 10x10	42
F	 14x4mm Sapata Deslizadora	04
G	 Adesivo Tapa Furo	04
H	 Perfil I 1492mm	01

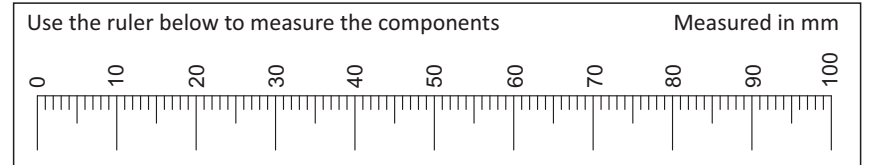

Revisão: 00  
Data: 18/07/2018

