

# ME - 4130

## Instruções de Montagem Assembly Instructions Instrucciones de Armado

WWW.MUEBLES2020.COM

**MUEBLES 2020**  
Fácil Armado

Carrera 15 # 110-71-Barrio Santa Paula  
Celular 3182000653/ Teléfono: 4660694

### Notas Especiais:

**01** -Examine completamente todas as peças do móvel antes de começar o trabalho.

**02** -Recomenda-se montar o móvel conforme este Manual de Montagem.

**03** -É de responsabilidade do montador seguir as instruções do Manual de Montagem, que são fundamentais para garantir a estrutura do móvel.

**04** -Para limpeza, utilizar somente pano úmido e sabão neutro.

### Special notes:

**01** -Check all parts of the unit thoroughly before starting work.

**02** -It is recommended to assemble the furniture according to this Installation Manual.

**03** -It is the responsibility of the assembler to follow the instructions in the Assembly Manual, which are essential to ensure the structure of the furniture.

**04** -For cleaning use only damp cloth and neutral soap.

### Notas especiales:

**01** -Examine completamente todas las piezas del mueble antes de iniciar el trabajo.

**02** -Se recomienda montar el mueble conforme el Manual de Ensamblaje.

**03** -Es de responsabilidad del montador seguir las instrucciones del Manual de Ensamblaje, que son fundamentales para garantizar la estructura del mueble.











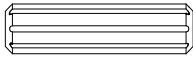

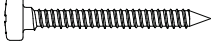
**04** -Para limpieza solamente usar trapo húmedo y jabón neutro.

### Guarante certificate:

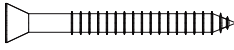
Garantia de 12 meses por defectos de fábrica. Se recomienda que este producto sea armado por un experto.

### Lista de Peças / List of pieces / Lista de piezas

| Cód | DESCRIÇÃO         | DESCRIPTION   | DESCRIPCION        | QTD | RAW MATERIAL   | DIMENSION   |
|-----|-------------------|---------------|--------------------|-----|----------------|-------------|
| 01  | Tampo             | Top           | Tapa               | 1   | MDP 15mm       | 1358x450x15 |
| 02  | Lateral           | Side          | Lateral            | 1   | MDP 15mm       | 725x450x15  |
| 03  | Divisão           | Division      | División           | 1   | MDP 15mm       | 472x450x15  |
| 04  | Lateral Gaveteiro | Drawer Side   | Lateral Cajón      | 1   | MDP 15mm       | 725x450x15  |
| 05  | Rodapé            | Baseboard     | Rodapié            | 1   | MDP 15mm       | 320x70x15   |
| 06  | Costa Maior       | Larger Back   | Revés Major        | 1   | MDP 15mm       | 1327x238x15 |
| 07  | Costa Menor       | Smaller Back  | Revés Menor        | 1   | Chapa Dura 3mm | 482x340x3   |
| 08  | Frente Gaveta     | Drawer Front  | Frente Cajón       | 2   | MDP 15mm       | 204x300x15  |
| 09  | Lateral Gaveta    | Drawer Side   | Lateral Cajón      | 4   | MDP 15mm       | 300x140x15  |
| 10  | Costa Gaveta      | Drawer Back   | Revés Cajón        | 2   | MDP 15mm       | 140x263x15  |
| 11  | Fundo Gaveta      | Drawer Bottom | Fondo Cajón        | 2   | Chapa Dura 3mm | 309x242x3   |
| 12  | Travessa          | Traverse      | Traviesa           | 1   | MDP 15mm       | 1358x45x15  |
| 13  | Travessa Direita  | RightTraverse | Traviesa Derecha   | 1   | MDP 15mm       | 741x45x15   |
| 14  | Travessa Esquerda | LeftTraverse  | Traviesa Izquierda | 1   | MDP 15mm       | 741x45x15   |
| 15  | Tampo Gaveta      | DrawerTop     | Tapa Cajón         | 1   | MDP 15mm       | 335x450x15  |

| REF | DESCRIÇÃO   | QTD |
|-----|---|-----|
| A   |  Cavilha 8 x 30mm                          | 10  |
| B   |  3,5 x 14mm CF                             | 28  |
| C   |  4,0 x 16mm CC                             | 16  |
| D   |  3,5 x 30mm CP                             | 02  |
| E   |  34 x 7mm Parafuso Minifix                 | 24  |
| F   |  15 x 12mm Tambor Minifix                  | 24  |
| G   |  7 x 5 x 14mm Malhete                      | 04  |
| H   |  22 x 17 x 12mm Suporte Angular            | 10  |
| I   |  3,5 x 40mm CC                             | 01  |
| J   |  32 x 45 x 20mm Distanciador de Corrediça | 04  |
| K   |  22 x 3mm Pregos 10 x 10                 | 20  |
| L   |  14 x 4mm Sapata Deslizadora             | 06  |
| M   |  Corrediça 350mm                         | 02  |
| N   |  40 x 20 x 21mm Puxador                  | 02  |
| O   |  Adesivo Tapa-Furo                       | 04  |

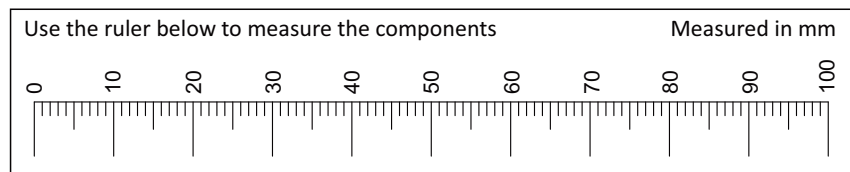
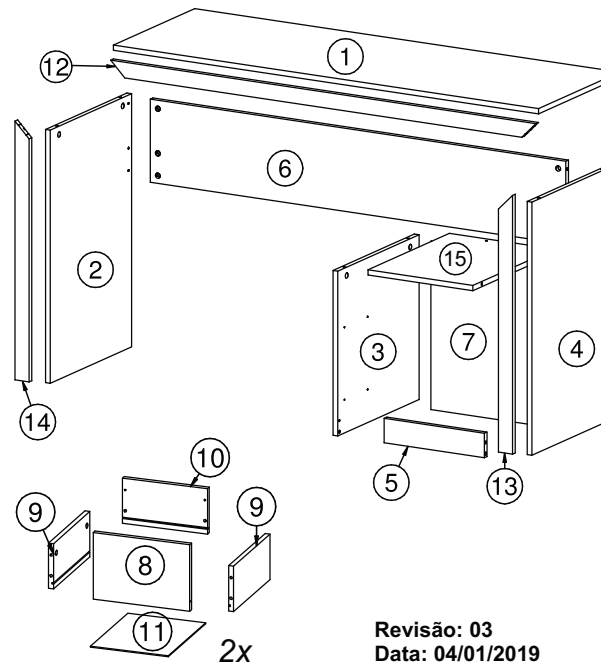

Revisão: 03  
Data: 04/01/2019

### Ferramentas | Tools | Herramientas

