

# ME 4123

## Instruções de Montagem Assembly Instructions Instrucciones de Armado

WWW.MUEBLES2020.COM

**MUEBLES 2020**  
Fácil Armado

Carrera 15 # 110-71-Barrio Santa Paula  
Celular 3182000653/ Teléfono: 4660694

### Notas Especiais:

**01** -Examine completamente todas as peças do móvel antes de começar o trabalho.

**02** -Recomenda-se montar o móvel conforme este Manual de Montagem.

**03** -É de responsabilidade do montador seguir as instruções do Manual de Montagem, que são fundamentais para garantir a estrutura do móvel.

**04** -Para limpeza, utilizar somente pano úmido e sabão neutro.

### Special notes:

**01** -Check all parts of the unit thoroughly before starting work.

**02** -It is recommended to assemble the furniture according to this Installation Manual.

**03** -It is the responsibility of the assembler to follow the instructions in the Assembly Manual, which are essential to ensure the structure of the furniture.

**04** -For cleaning use only damp cloth and neutral soap.

### Notas especiales:

**01** -Examine completamente todas las piezas del mueble antes de iniciar el trabajo.

**02** -Se recomienda montar el mueble conforme el Manual de Ensamblaje.

**03** -Es de responsabilidad del montador seguir las instrucciones del Manual de Ensamblaje, que son fundamentales para garantizar la estructura del mueble.

**04** -Para limpieza solamente usar trapo húmedo y jabón neutro.

### Guarante certificate:



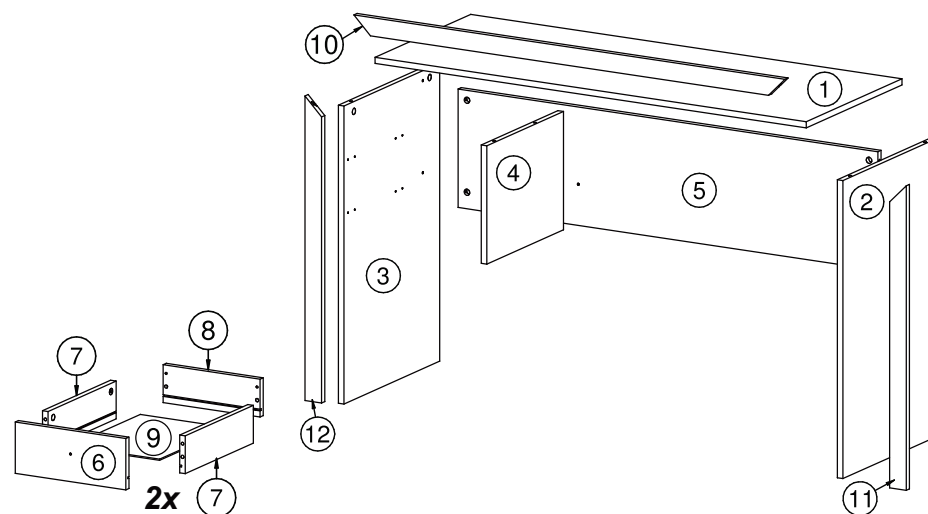

Garantia de 12 meses por defectos de fábrica. Se recomienda que este producto sea armado por un experto.

### Lista de Peças / List of pieces / Lista de piezas

CÓD	DESCRIÇÃO	DESCRIPTION	DESCRIPCIÓN	QTD	M. PRIMA	DIMENSÕES
01	Tampo	Top	Tapa	1	MDP 15mm	1170x450x15
02	Lateral Direita	Right Side	Lateral Dereita	1	MDP 15mm	725x450x15
03	Lateral Esquerda	Left Side	Lateral Esquerda	1	MDP 15mm	725x450x15
04	Divisão	Divison	Division	1	MDP 15mm	360x288x15
05	Costa	Back	Revés	1	MDP 15mm	1139x288x15
06	Frente Gaveta	Drawer Front	Frente Cajón	2	MDP 15mm	125x300x15
07	Lateral Gaveta	Drawer Side	Lateral Cajón	4	MDP 15mm	320x92x15
08	Costa Gaveta	Drawer Back	Revés Cajón	2	MDP 15mm	263x92x15
09	Fundo Gaveta	Drawer Bottom	Fondo Cajón	2	Chapa Dura 3mm	329x240x15
10	Travessa Frontal	FrontTraverse	Traviesa Frontal	1	MDP 15mm	1170x45x15
11	Travessa Direita	RightTraverse	Traviesa Derecha	1	MDP 15mm	741x45x15
12	Travessa Esquerda	LeftTraverse	Traviesa Izquierda	1	MDP 15mm	741x45x15

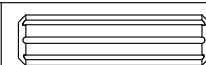
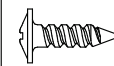
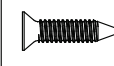
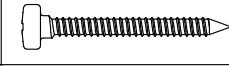
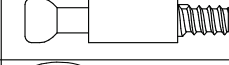

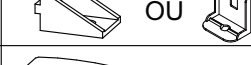
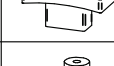
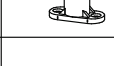
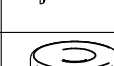
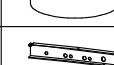
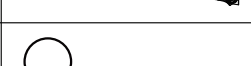
### REF DESCRIÇÃO QTD

A	 Cavilha 8 x 30mm	08
B	 3,5 x 14mm CF	28
C	 4,0 x 16mm CC	16
D	 3,5 x 30mm CP	02
E	 34 x 7mm Parafuso Minifix	19
F	 15 x 12mm Tambor Minifix	19
G	 7 x 5 x 14mm Malhete	04
H	 22 x 17 x 12mm Suporte Angular	10
I	 40 x 20 x 21mm Puxador	02
J	 32 x 45 x 20mm Distanciador de Corrediça	04
K	 22 x 3mm Pregos 10 x 10	04
L	 14 x 4mm Sapata Deslizadora	04
M	 Corrediça 350mm	02
N	 Tapa Furo	03

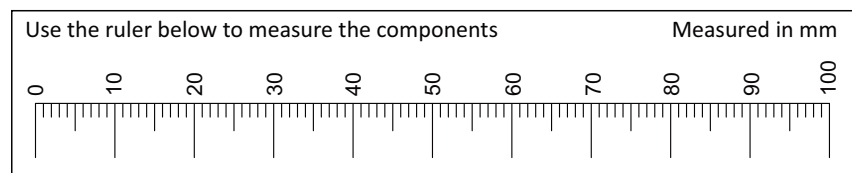

Revisão: 06  
Data: 04/01/2018

### Ferramentas | Tools | Herramientas

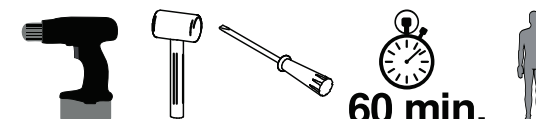

60 min.

