

Al finalizar el ajuste de los conectores, proceda a poner las tapas adhesivas/  
When you finish the adjustment of the connectors, proceed to put the cover tapes

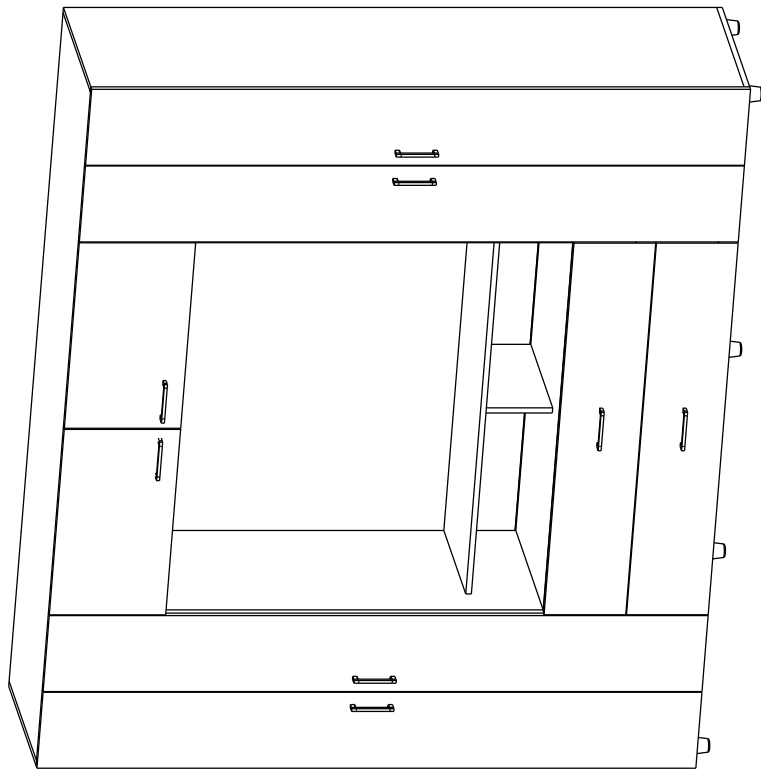

Alto/ Height: 179,85 cm  
Ancho/ Width: 198,4 cm  
Fondo/ Depth: 49,55 cm

LOTE No: \_\_\_\_\_

By: **RTA**® TEL (572) 691 17 00  
PBX (572) 695 91 81  
m u e b l e s  
CALLI - COLOMBIA  
[www.rta.com.co](http://www.rta.com.co)

**CLOSET MANILA Z 200-190**  
/Manila Wardrobe Z 200-190



**NO OLVIDE:**  
Los tubos cromados se deben colocar entre las piezas D y F

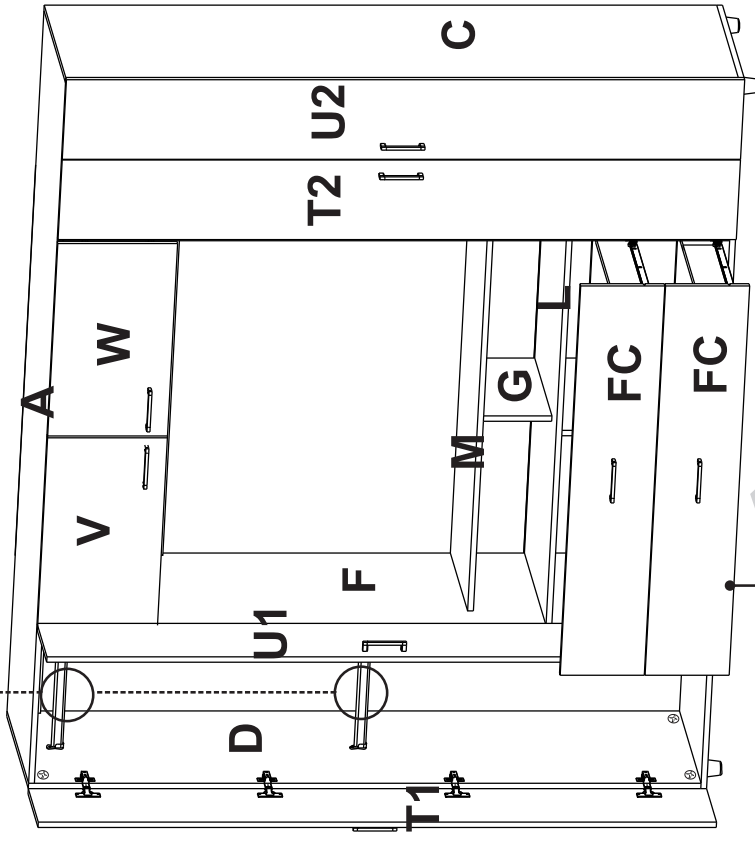
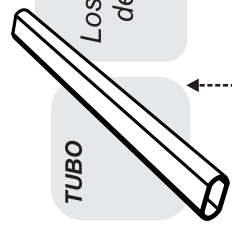

Introduzca los cajones en la estructura

**RECOMENDACIONES IMPORTANTES**  
KEY RECOMMENDATIONS

<p>NO pinte el mueble / Do not paint the furniture.</p>	<p>NO mojar o ubicar a la intemperie / Do not expose to rain or direct sun.</p>	<p>NO lavar las manijas o tiraderas con jabones o elementos abrasivos / Do not wash handles or dunks with soap or abrasives.</p>
	<p>NO golpear ni martillar el mueble (hágalo sólo donde se indique) / Do not hit or hammer the furniture (just do it where is indicated).</p>	
	<p>SIEMPRE levante el mueble entre dos personas, NO lo arrastre / Do not drag the furniture. Lift it between two people.</p>	
	<p>3. Separe los herrajes para facilitar su identificación durante el armado / Separate hardware for easy identification during assembly.</p>	
	<p>4. Arme el mueble en un lugar limpio y en una superficie plana / RTA furniture must be assembled in a clean place and on a flat surface.</p>	

**HERRAJES BÁSICOS PARA MUEBLES RTA**  
BASIC HARDWARE FOR RTA FURNITURE

	<p>1. Abrir la caja del mueble y buscar la bolsa con los herrajes / Open the box and look for the hardware bag.</p>	
	<p>2. Abrir el paquete y comprobar que el contenido de las piezas es correcto / Open the package and verify that the content of the pieces is correct.</p>	

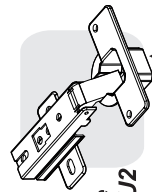

Bisagra parche  
Puertas: T1 Y U2



Tenga en cuenta: Voltar el mueble cuidadosamente.

IMPORTANTE

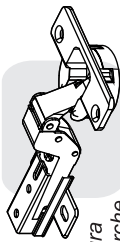
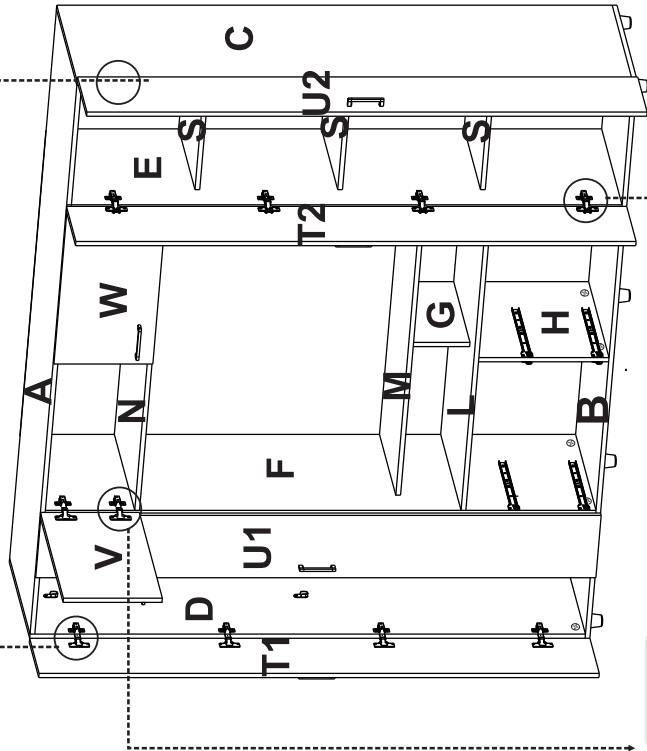

Bisagra Semi-parche  
Puertas: U1, T2, V y W

**INSTALACIÓN BISAGRAS**  
aplica para todas las bisagras

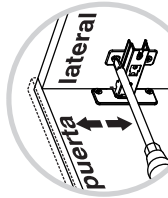
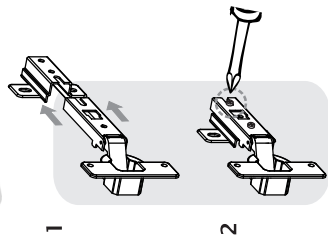

AJUSTE DE ALTURA

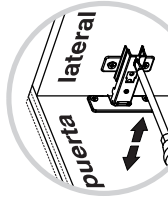

AJUSTE DE PROFUNDIDAD

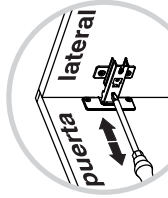

AJUSTE LATERAL

**RECOMENDACIONES DE ENSAMBLE**  
/ ASSEMBLY RECOMMENDATIONS

El buen funcionamiento del mueble depende de un adecuado ensamblaje  
An excellent furniture's performance relies on a solid and a suitable assembly.

**MINIFIX / CONNECTOR - DOWELS**

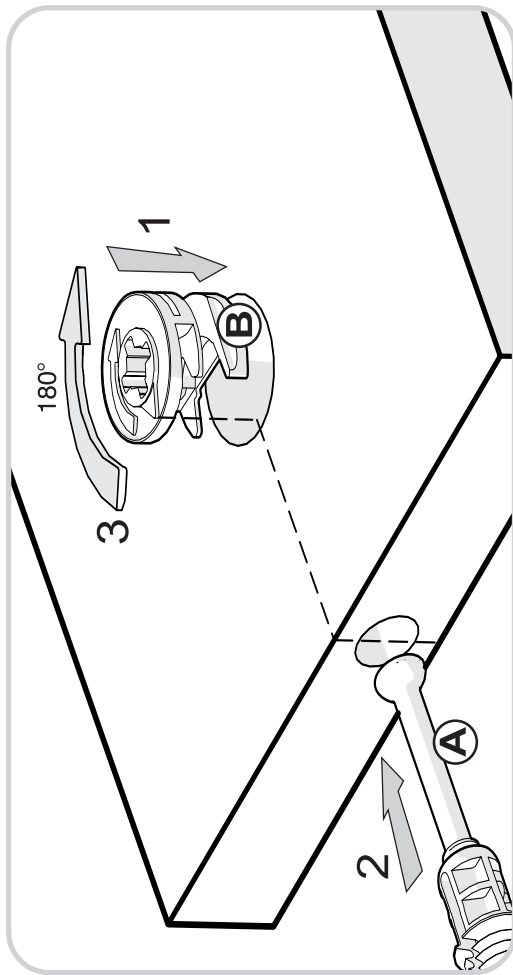

Sistema de unión compuesto por un perno (A) y una caja minifix (B).

(1) Se inserta la caja minifix dentro de la perforación ubicada en la cara de la pieza, la flecha debe apuntar siempre a la dirección de la perforación por donde entrará el perno.

(2) Se debe insertar el perno por su parte plástica en las perforaciones que se indiquen, luego se inserta la punta metálica en la perforación para que su cabeza quede al interior de la caja minifix.

(3) Girar la caja minifix 180° para apretar las dos piezas.

It's a fitting system made of a spreading bolt (A) and a minifix cam (B).

(1) Insert the minifix cam in the hole placed in the face of the panel with the arrow pointing towards the hole where the bolt will fit.

(2) Insert the bolt with its plastic base in the shown holes, then insert the metallic bolt head in the holes so it fits inside the minifix cam.





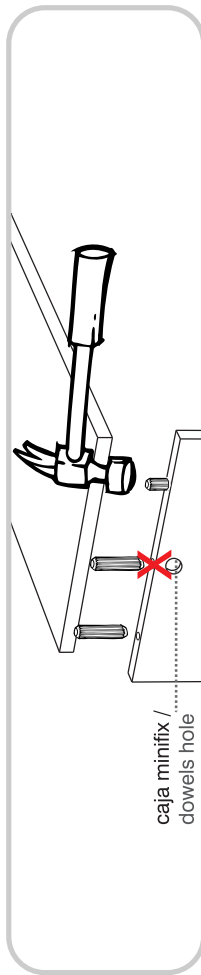



(3) Tight the panels by turning the minifix cam 180°.

**TARUGOS O TAQUETES / FLUTED DOWEL PIN**

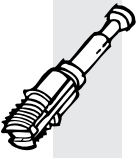
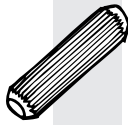

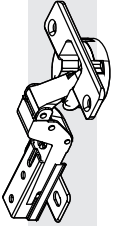
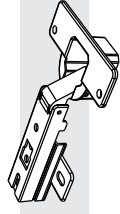
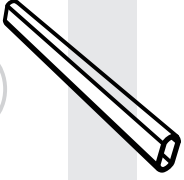
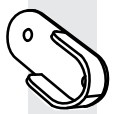
Es un pedazo de madera corto y grueso, de aproximadamente 3 a 10 cm de largo, que sirve para amarrar el mueble y darle resistencia.  
It's a short and thick piece of wood, 1, 18 to 3,9 inches approximately, which is used to tie the cabinet and give it resistance.

## HERRAJES PARA ARMADO ASSEMBLE HARDWARE

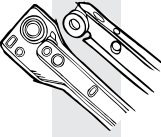
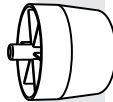
	<b>x120</b>		<b>x52</b>		<b>x52</b>		<b>x87</b>		<b>x8</b>
Tornillo lámina 6 X 9/16"		Minifix/ Minifix Cams		Perno minifix/ Spreading Bolt		Tarugo/ Wooden Pin		Manija Zamak 96mm/ Handle	
	<b>x12</b>		<b>x8</b>		<b>x2</b>		<b>x4</b>		<b>x16</b>
Bisagra Semiparache 35mm/ Half Overlay Hinge		Bisagra Parache 35mm/ Full Overlay Hinge		Tubo Ovalado/ Closet Rod		SopORTE Tubo Ovalado/ Closet Rod Support		Tornillo Manija/ Handle Screw	
	<b>x90</b>		<b>x52</b>		<b>x16</b>		<b>x4</b>		<b>x8</b>
Puntillas/ Panel Pin		Tapa Adhesiva Minifix/ Cover Caps		Tornillo de Ensamble 2"/ Drywall Screw		Riel Sencillo 35cm/ Drawer Slides		Deslizador 40mm/ Plastic Glide	



**IMPORTANTE**

TENER PRECAUCIÓN AL ABRIR LA BOLSA DE HERRAJES PARA NO EXTRAIAR NINGUNO. COMPRUEBE QUE EL CONTENIDO DE LAS PIEZAS SEA EL CORRECTO. EN CASO QUE FALTE ALGUNA PIEZA O ESTE DEFECTUOSA DEVUELVA LAS PIEZAS AL ALMACEN CON SU FACTURA PARA EFECTUAR EL CAMBIO DE LAS PIEZAS Y/O LOS HERRAJES LO MAS PRONTO POSIBLE. / PLEASE BE CAUTIOUS WHEN OPENING THE HARDWARE BAG TO NOT LOSE ANY. CHECK THE CONTENTS OF THE STORE WITH THE PRODUCT INVOICE ATTACHED TO MAKE EFFECTIVE THE REPLACEMENT OF THE DEFECTIVE PIECES OR WARDWARE AS SOON AS POSSIBLE.

**13**

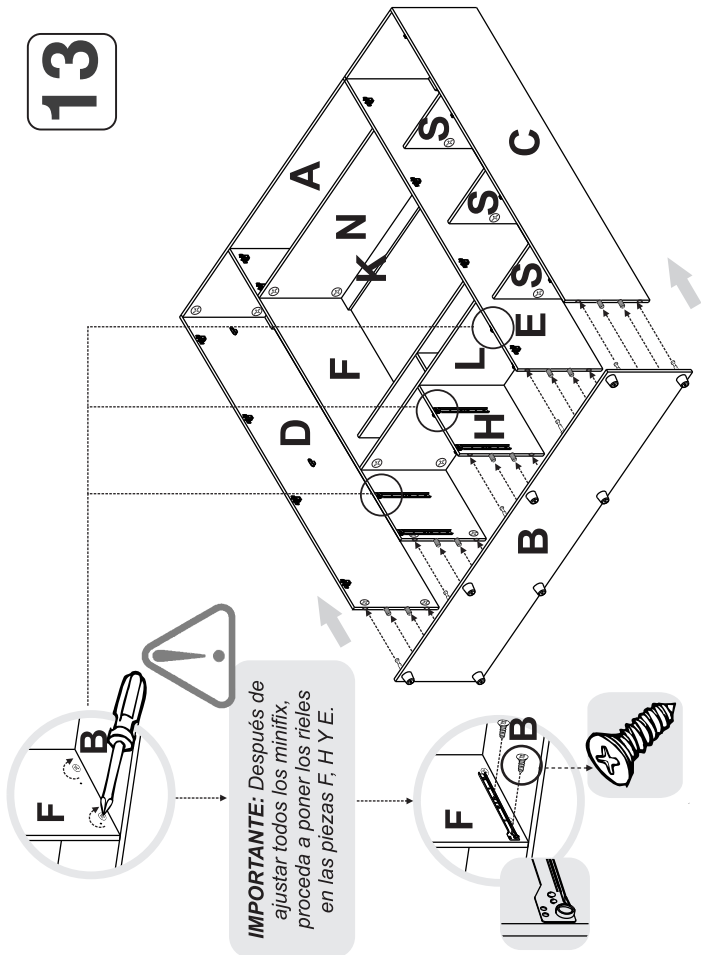

**IMPORTANTE:** Después de ajustar todos los minifix, proceda a poner los rieles en las piezas F, H, Y, E.

**14**

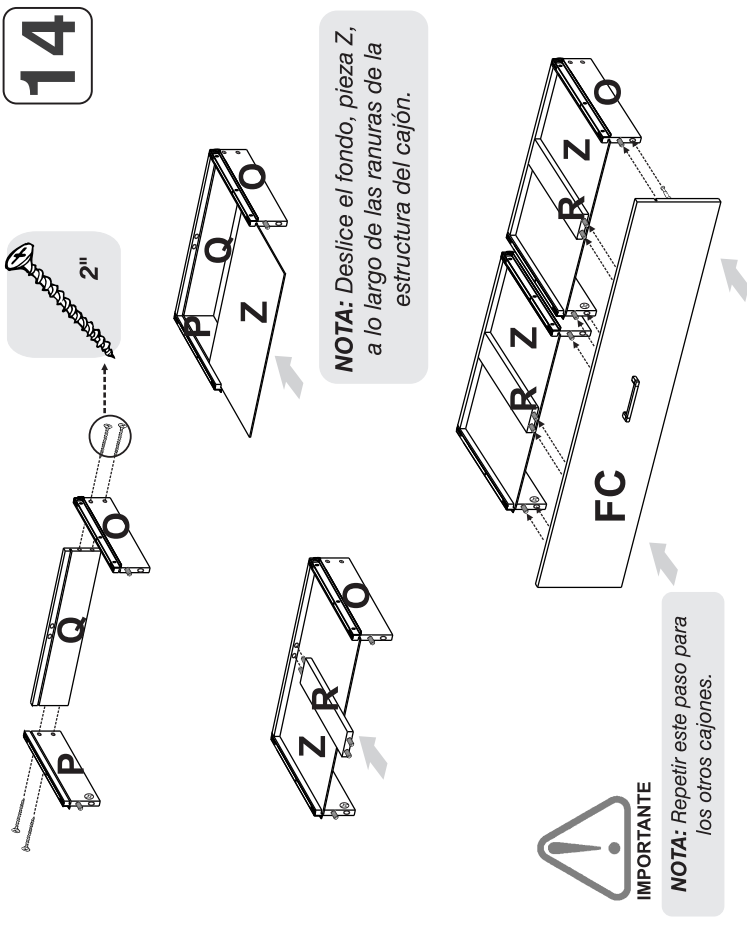

**NOTA:** Deslice el fondo, pieza Z, a lo largo de las ranuras de la estructura del cajón.



**IMPORTANTE**  
**NOTA:** Repetir este paso para los otros cajones.

PIEZAS DE ARMADO  
ASSEMBLY PARTS

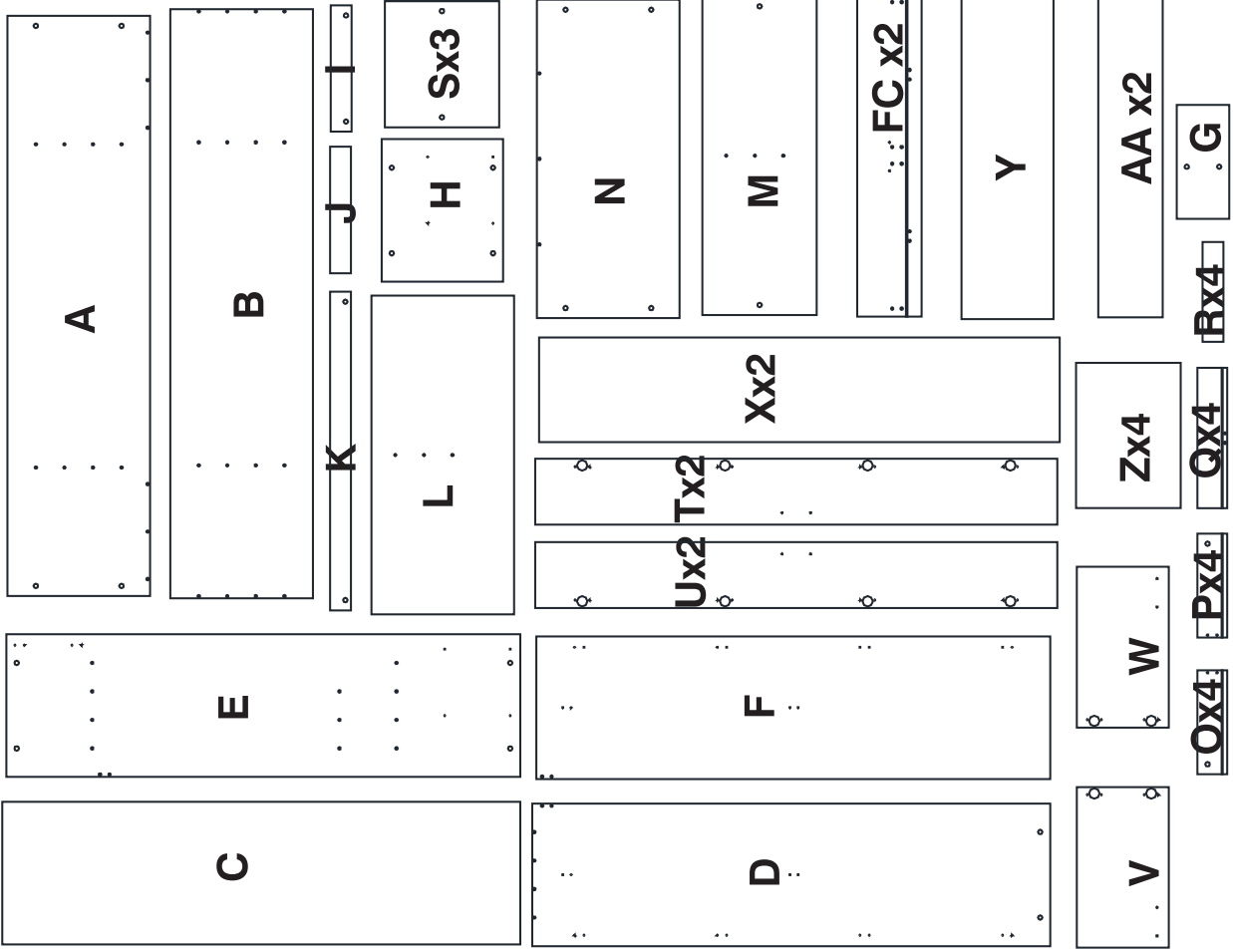

11

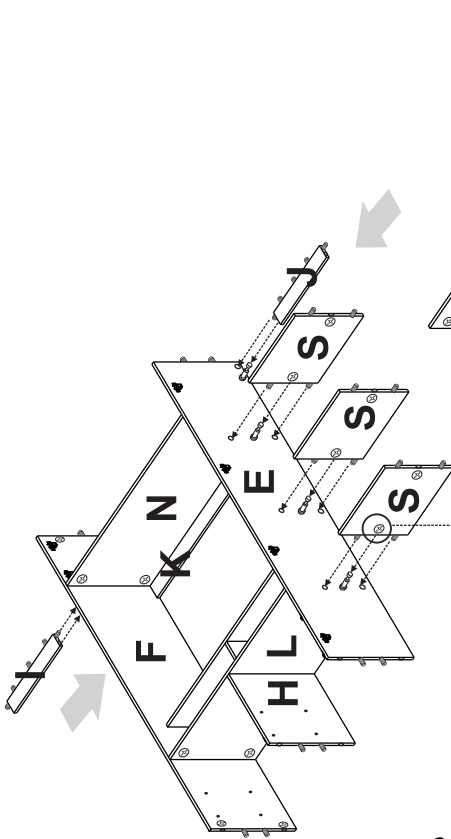

Girar 180° /  
Rotate 180°



12

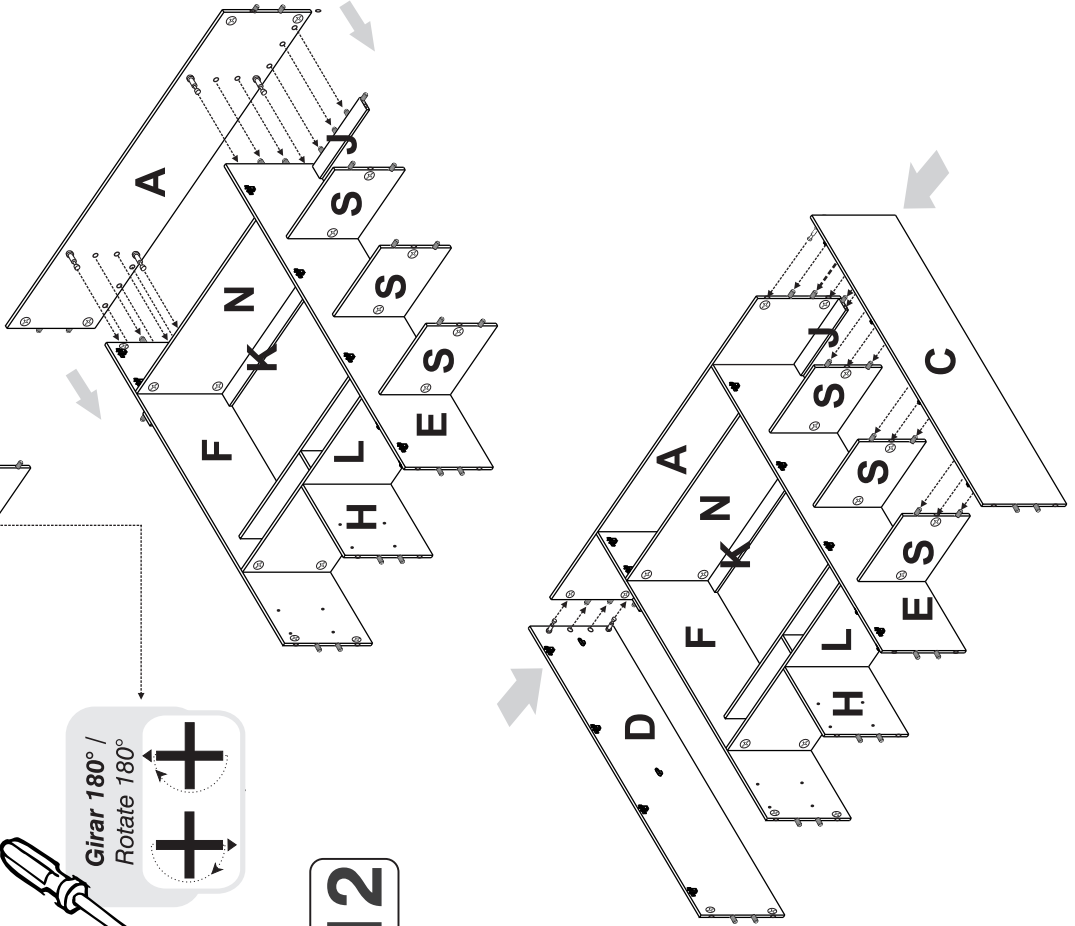

ANTES DE EMPEZAR A ARMAR EL MUEBLE LEA DETENIDAMENTE LAS INSTRUCCIONES.  
SE RECOMIENDA ARMAR EL MUEBLE ACOSTADO SOBRE LA CAJA  
O SOBRE UNA SUPERFICIE LISA Y CUBIERTA, PARA NO RAYARLO.

IMPORTANTE

\*

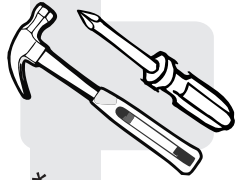

\*(Herramientas NO incluidas)

\*Tools NOT Included

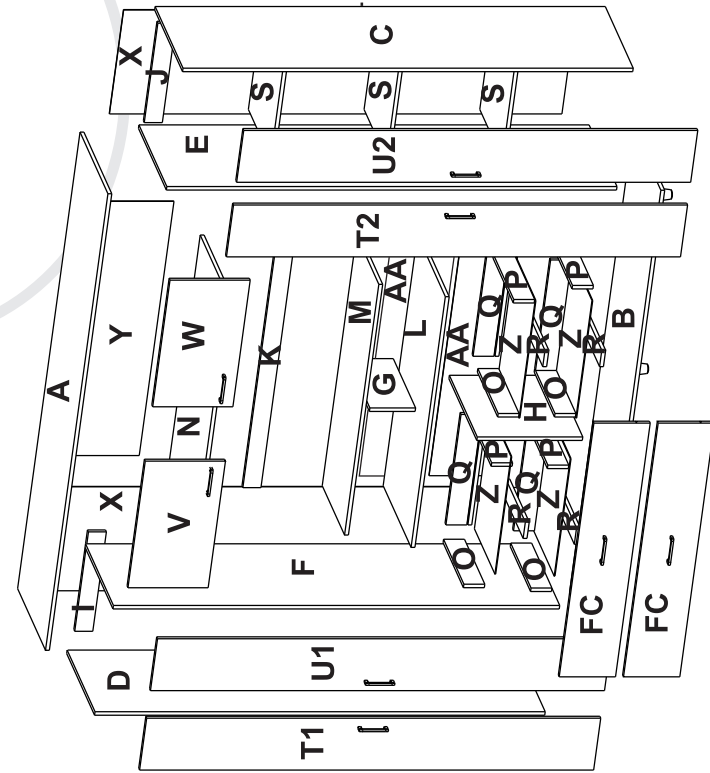
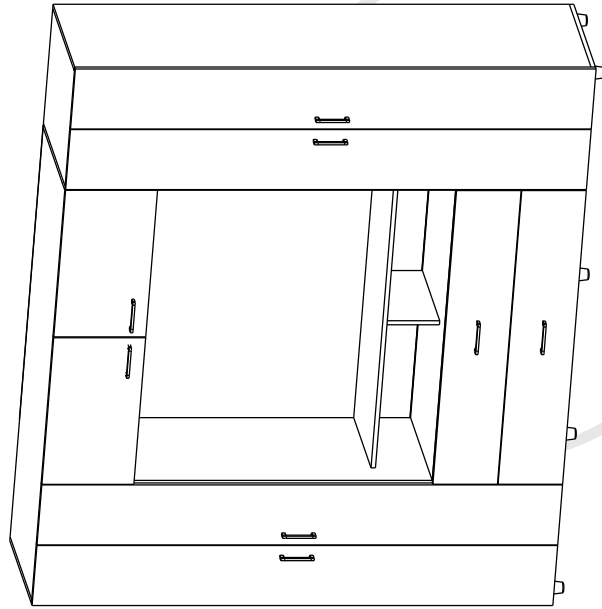

SE RECOMIENDA ARMAR EL MUEBLE SOBRE LA CAJA O SOBRE UNA SUPERFICIE LISA, PARA NO RAYARLO / IT IS RECOMMENDED TO ASSEMBLE THE PRODUCT ON THE BOX OR ON A PLANE SURFACE FOR NOT SCRATCH IT.



9

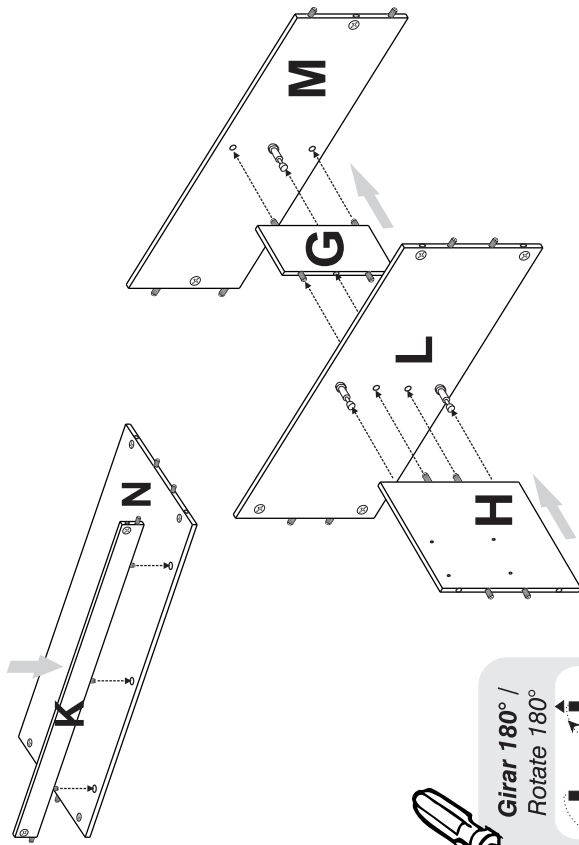

Girar 180° / Rotate 180°



10

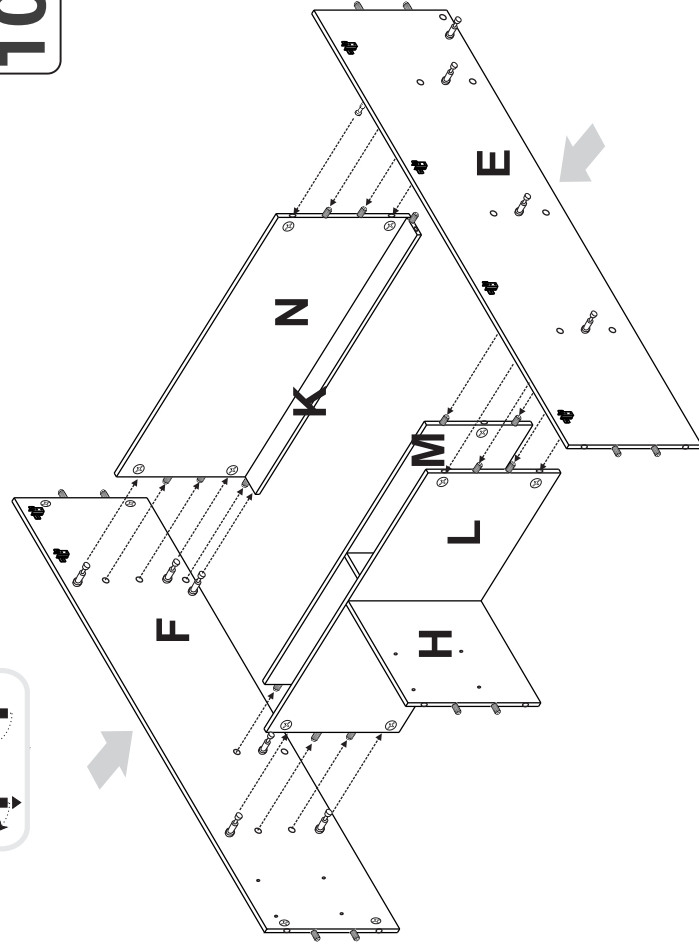



SE RECOMIENDA ARMAR EL MUEBLE ENTRE DOS PERSONAS /  
IT IS RECOMMENDED TO ASSEMBLE THE PRODUCT BETWEEN TWO PEOPLE

1

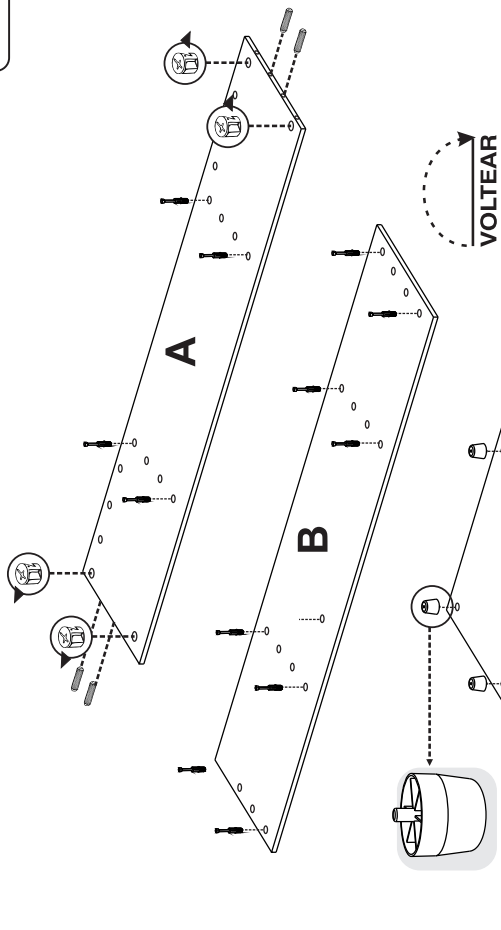

2

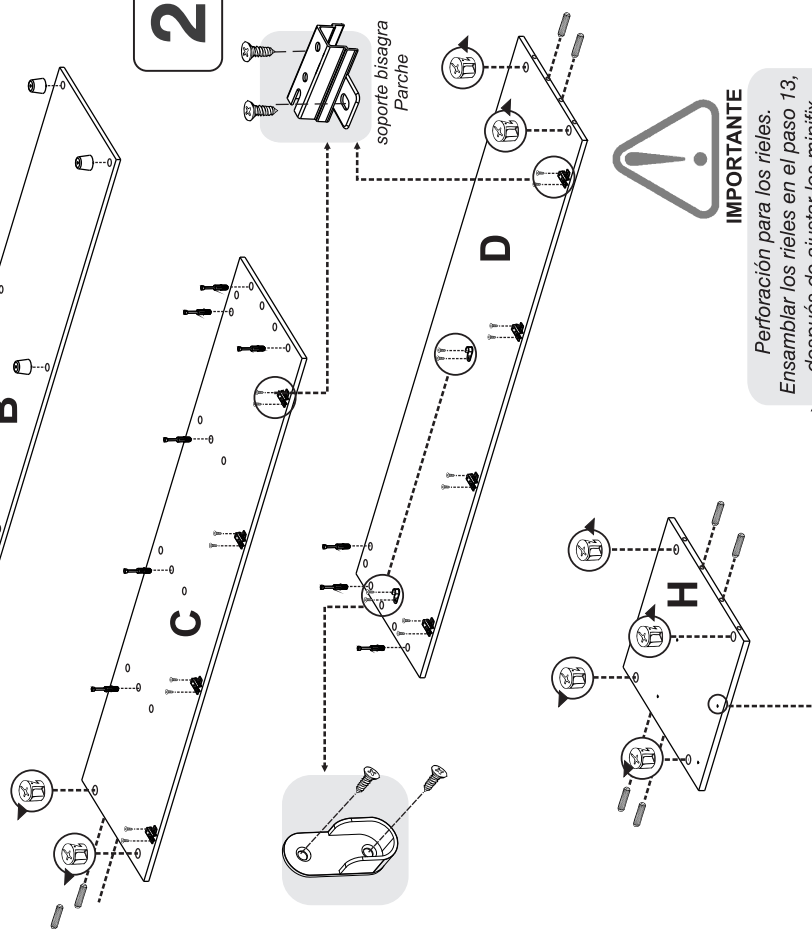

**IMPORTANTE**

Perforación para los rieles.  
Ensamblar los rieles en el paso 13,  
después de ajustar los minifix.

7

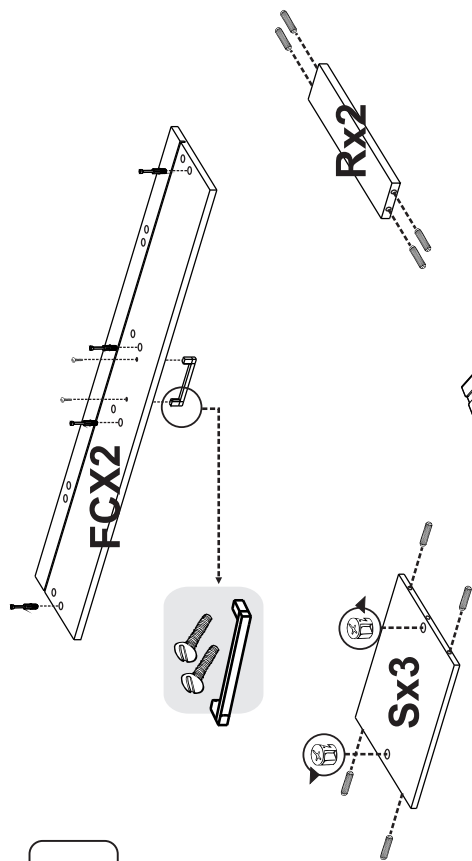

8

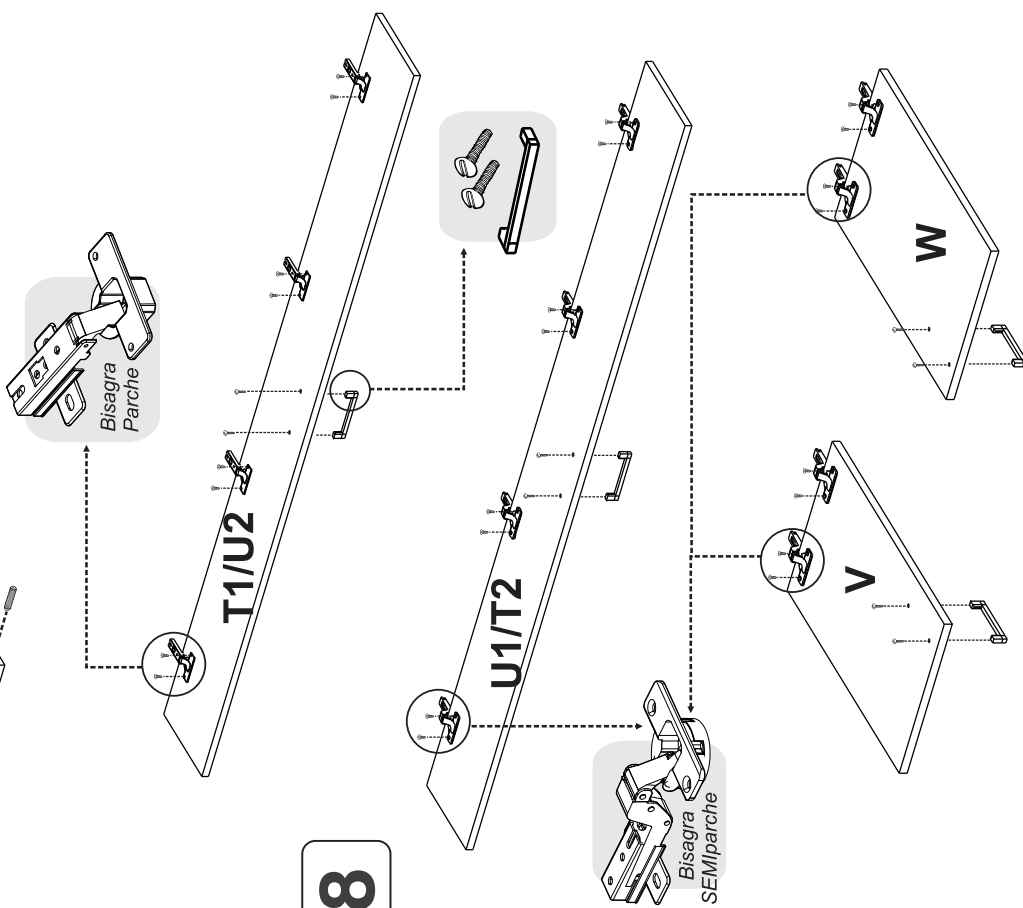

3

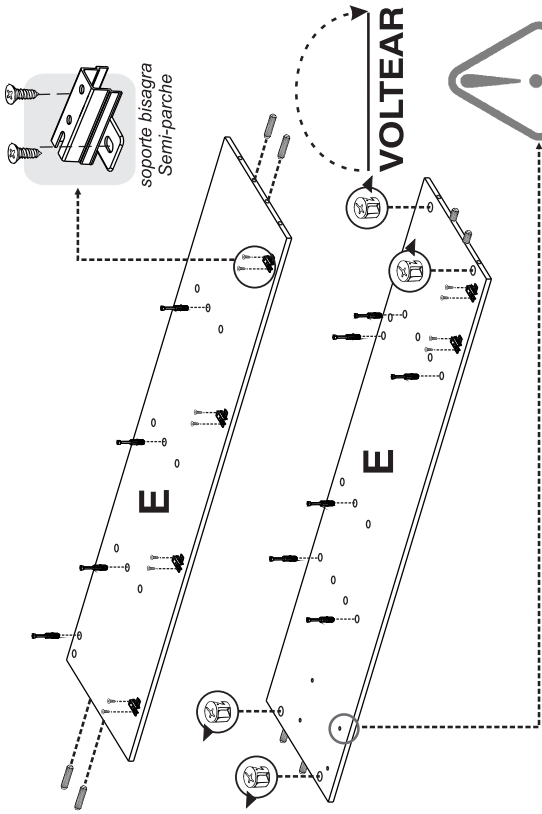

**IMPORTANTE**  
 Perforación para los rieles.  
 Ensamblar los rieles en el paso 13,  
 después de ajustar los minifix.

4

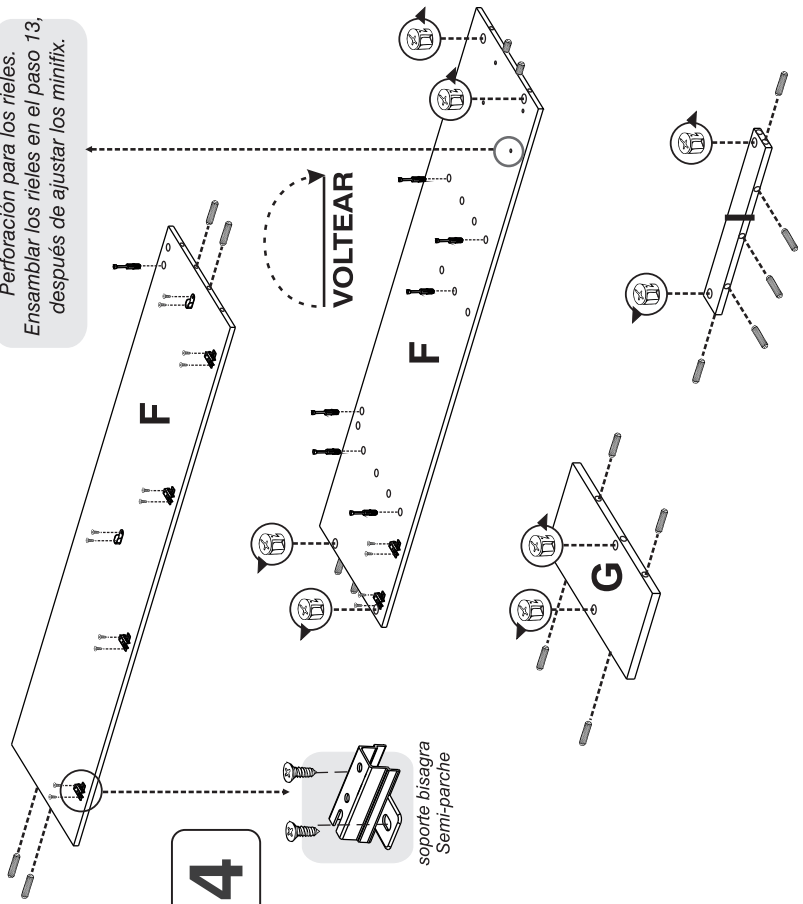

5

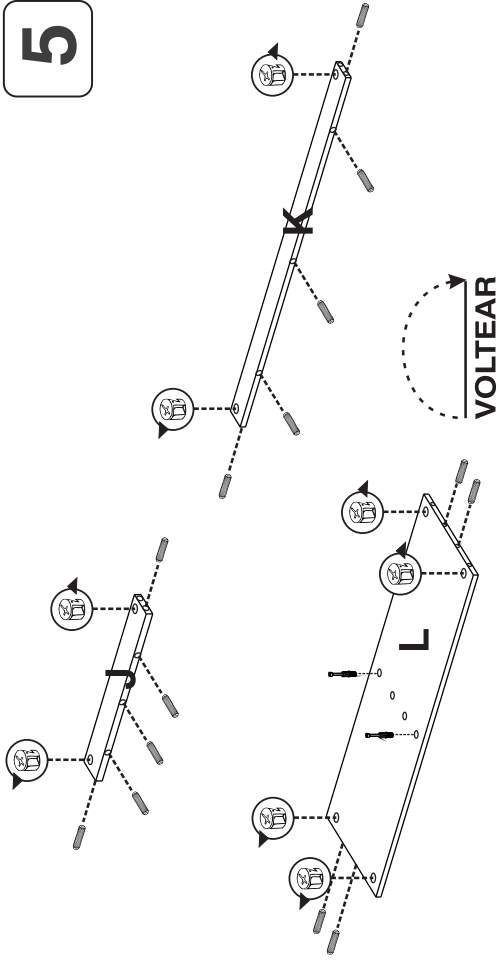

6

