

Anclaje a la pared /
Wall Anchoring

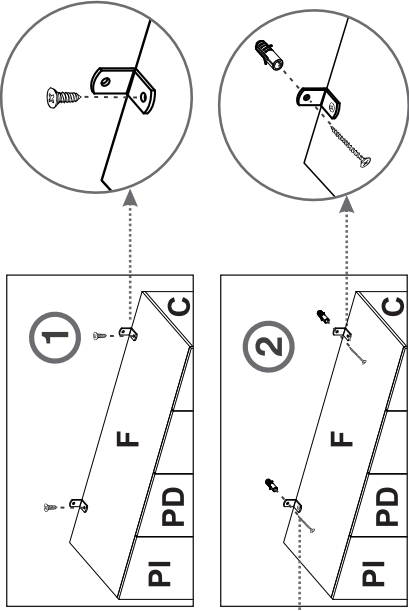

Chazo Plástico +
Tornillo de Ensamble/
Plastic Wall Anchor +
Drywall Screw

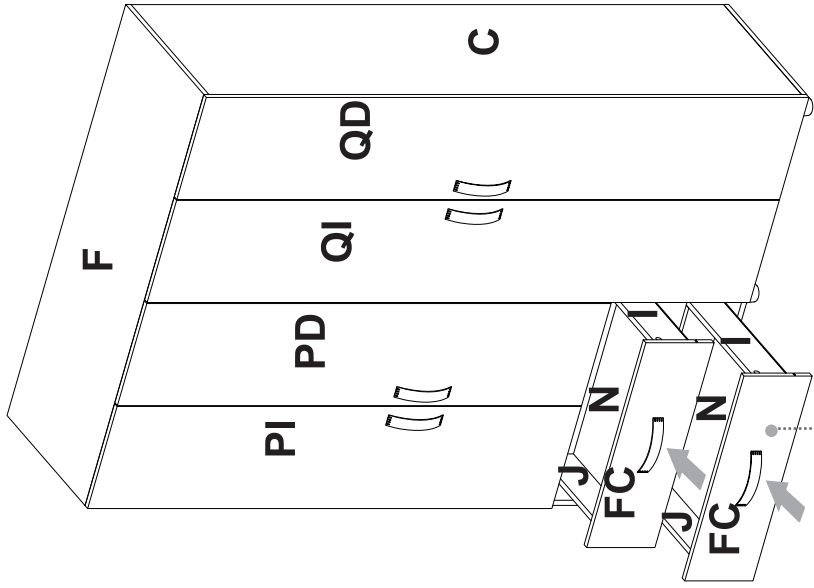

**Deslice los cajones dentro
del mueble / Slide the
drawers inside the cabinet**

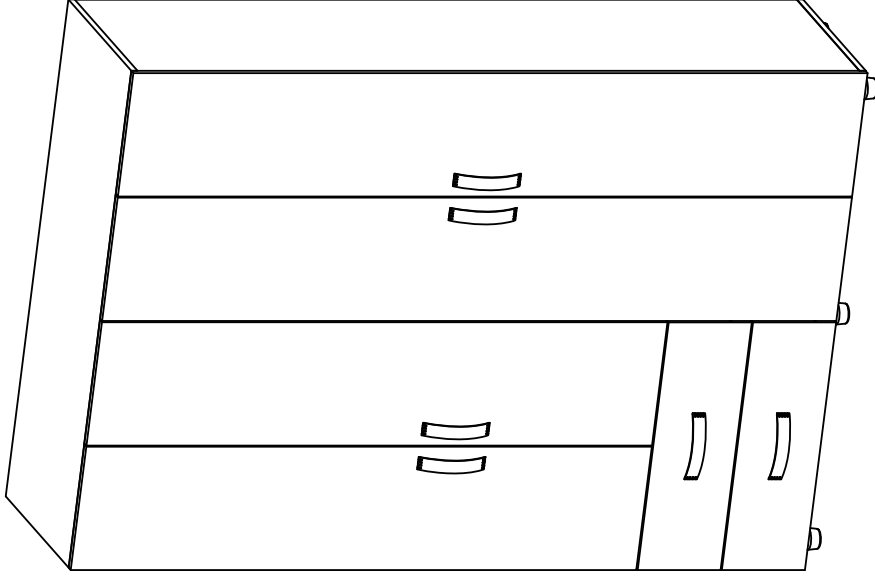

Alto/ Height: 180 cm / 70.86 in
Ancho/ Width: 120 cm / 47.24 in
Fondo/ Depth: 47.35 cm / 18.64 in

LOTE No: _____

RECOMENDACIONES IMPORTANTES KEY RECOMMENDATIONS

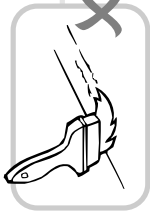

NO pinte el mueble /
Do not paint the
furniture.

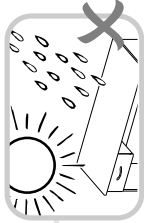

NO mojar o ubicar
a la intemperie /
Do not expose to rain
or direct sun.

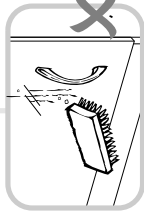

NO lavar las manijas o
tiraderas con jabones o
elementos abrasivos /
Do not wash handles
or dumbs with soap or
abrasives.

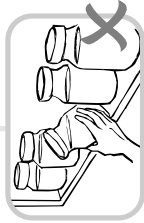

NO sobrecargue el mueble.
no exceda el peso de 30 kilos
para gabinetes de cocina /
Do not overload the cabinet.
Weight max. 66lbs
for kitchen cabinets.

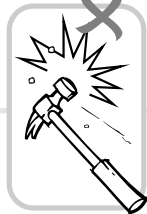

NO golpear ni martillar
el mueble (hágalo sólo
donde se indique) /
Do not hit or hammer
the furniture (just do it
where is indicated).

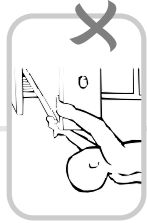

NO permita que los niños
manipulen el mueble, puede
voltearse y lastimarnos /
Do not allow children to
handle the cabinets or
drawers, they could get hurt.



SIEMPRE levante el
mueble entre dos
personas, NO lo arrastre /
Do not drag thefurniture.
Lift it between two people.



Limpie con paño seco.
/ Clean with a dry cloth.

HERRAJES BÁSICOS PARA MUEBLES RTA BASIC HARDWARE FOR RTA FURNITURE

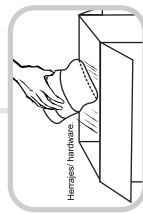

1. Abrir la caja del mueble
y buscar la bolsa con los
herrajes / Open the box
and look for the hardware
bag.

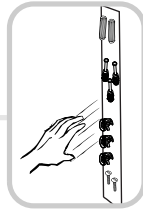

3. Separe los herrajes para
facilitar su identificación
durante el armado /
Separate hardware for easy
identification during
assembly.

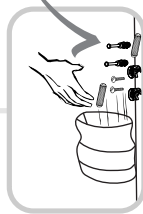

2. Abrir el paquete y
comprobar que el
contenido de las piezas es
correcto / Open the
package and verify that
the content of the pieces
is correct.

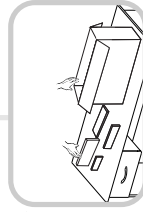

4. Arme el mueble en un lugar
limpio y en una superficie
plana / RTA furniture
must be assembled
in a clean place and on
a flat surface.

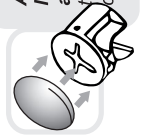
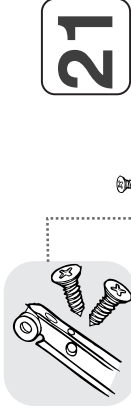
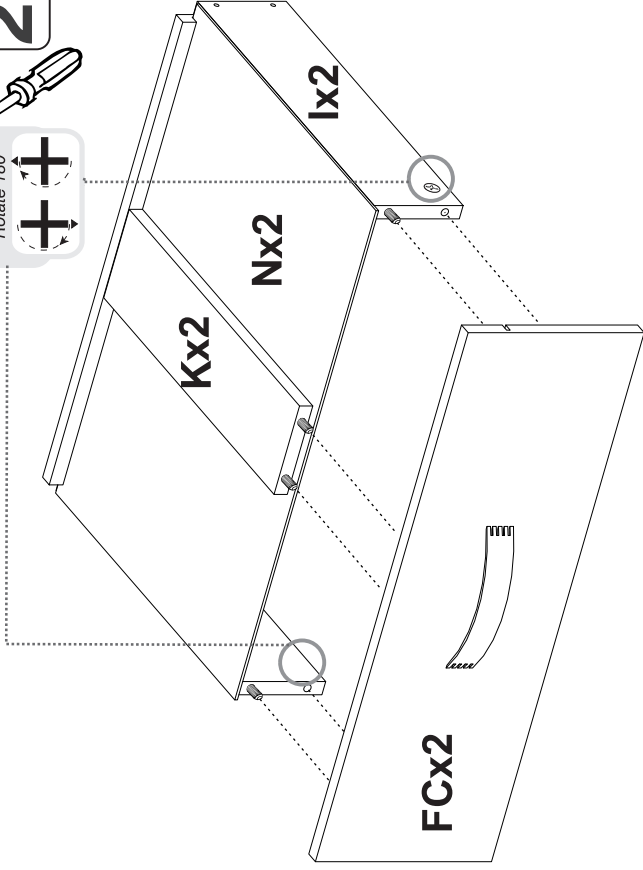

Al finalizar el ajuste, cubra
las cajas con las tapas
adhesivas/ After tightening all
the panels, cover the minifix
cams with the adhesive caps.



Al terminar de armar, despegue
los adhesivos (en caso de que
queden residuos de pegamento,
limpie la superficie con alcohol) /
After finishing the assembly, take off
the adhesives. (In case of glue
residues, wipe them with alcohol)

18

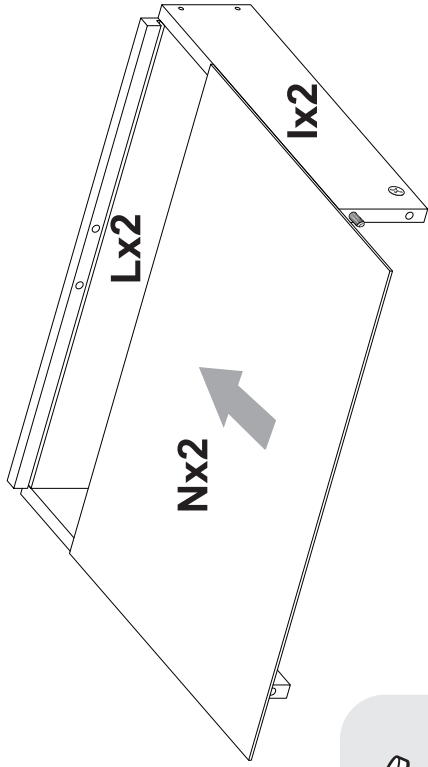

19

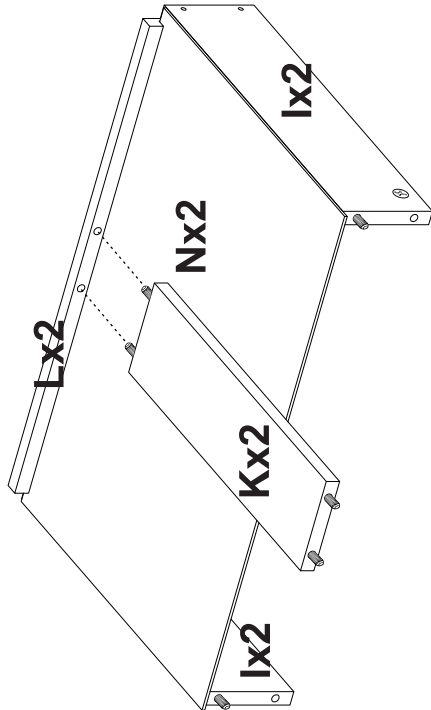
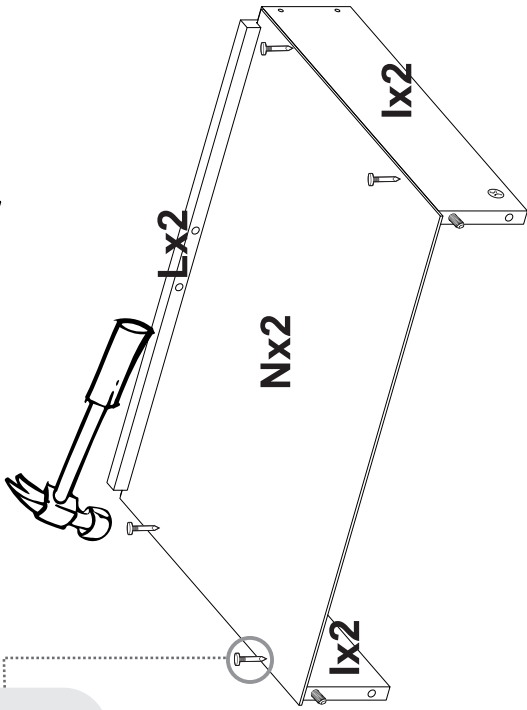

RECOMENDACIONES DE ENSAMBLE / ASSEMBLY RECOMMENDATIONS

El buen funcionamiento del mueble depende de un adecuado ensamblaje
An excellent furniture's performance relies on a solid and a suitable assembly.

MINIFIX / CONNECTOR - DOWELS

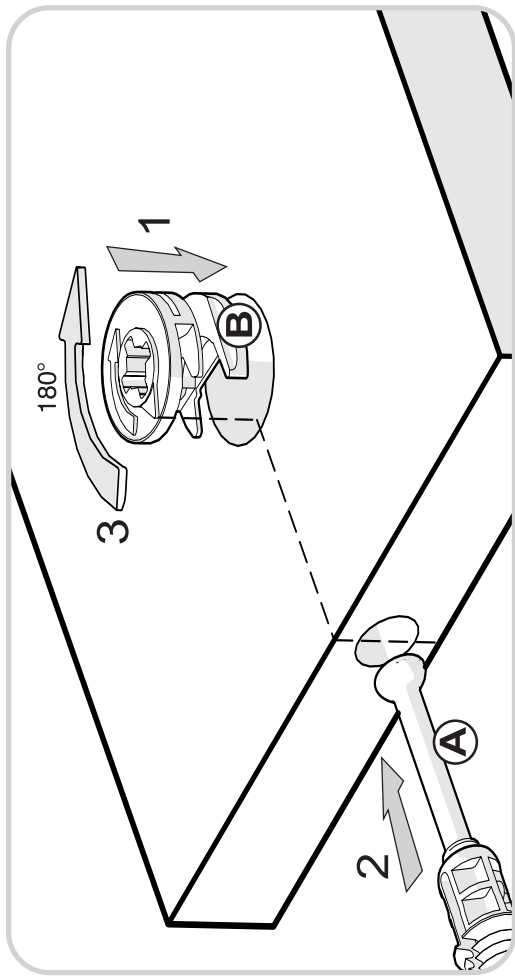

Sistema de unión compuesto por un perno (A) y una caja minifix (B).

(1) Se inserta la caja minifix dentro de la perforación ubicada en la cara de la pieza, la flecha debe apuntar siempre a la dirección de la perforación por donde entrará el perno.

(2) Se debe insertar el perno por su parte plástica en las perforaciones que se indiquen, luego se inserta la punta metálica en la perforación para que su cabeza quede al interior de la caja minifix.

(3) Girar la caja minifix 180° para apretar las dos piezas.

It's a fitting system made of a spreading bolt (A) and a minifix cam (B).

(1) Insert the minifix cam in the hole placed in the face of the panel with the arrow pointing towards the hole where the bolt will fit.

(2) Insert the bolt with its plastic base in the shown holes, then insert the metallic bolt head in the holes so it fits inside the minifix cam.

(3) Tight the panels by turning the minifix cam 180°.

TARUGOS O TAQUETES / FLUTED DOWEL PIN

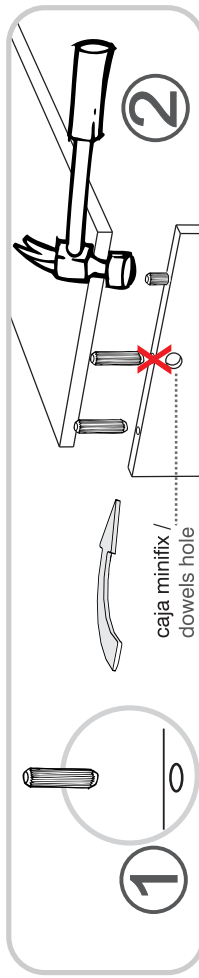

Es un pedazo de madera corto y grueso, de aproximadamente 5 a 10 cm de largo, que sirve para amarrar el mueble y darle resistencia.

It's a short and thick piece of wood, 1,9 to 3,9 inches approximately, which is used to tie the cabinet and give it resistance.

HERRAJES PARA ARMADO ASSEMBLY HARDWARE

x38



Tarugo/
Fluted Dowel Pin

x26

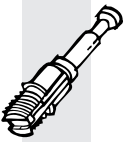

Perno minifix/
Spreading Bolt

x26



Minifix/
Minifix Cam

x8

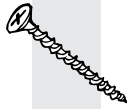

Tornillo de
Ensamble 2"/
Drywall Screw

x6

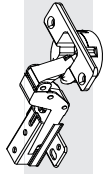

Bisagra Semi
Parche 35mm/
Half Overlay Hinge

x6

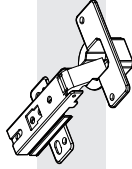

Bisagra Parche
35mm/
Full Overlay Hinge

x6

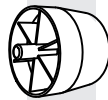

Deslizador 40mm/
Plastic Glide

x12



Tornillo Manija/
Handle Screw

x6



Manija Arco/
Handle



TENER PRECAUCIÓN AL ABRIR LA BOLSA DE HERRAJES PARA NO EXTRAVIAR NINGUNO. COMPRUEBE QUE EL CONTENIDO DE LAS PIEZAS SEA EL CORRECTO. EN CASO QUE FALTE ALGUNA PIEZA O ESTÉ DEFECTUOSA DEVUELVA LAS PIEZAS AL ALMACÉN CON SU FACTURA PARA EFECTUAR EL CAMBIO DE LAS PIEZAS Y/O LOS HERRAJES LO MÁS PRONTO POSIBLE. / PLEASE BE CAUTIOUS WHEN OPENING THE HARDWARE BAG TO NOT LOSE ANY. CHECK THE CONTENTS OF THE PARTS ARE CORRECT. IF ANY PART IS MISSING OR IMPERFECT PLEASE RETURN THE PARTS TO THE STORE WITH THE PRODUCT INVOICE ATTACHED TO MAKE EFFECTIVE THE REPLACEMENT OF THE IMPERFECT PIECES OR HARDWARE AS SOON AS POSSIBLE.

16

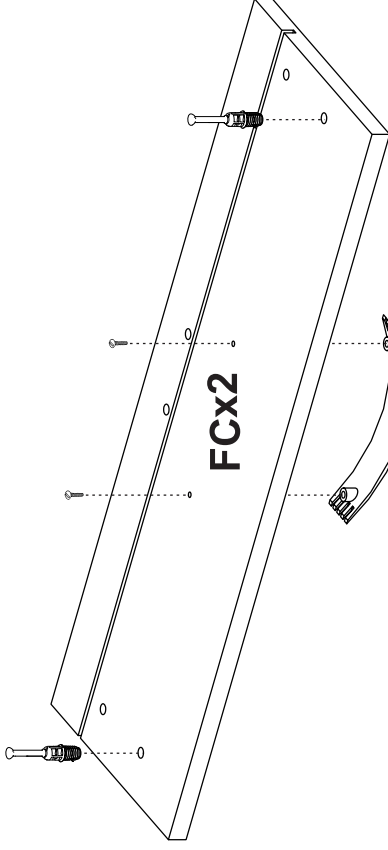

FCx2

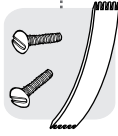

17

Tornillo Ensamble/
Drywall screw
2"

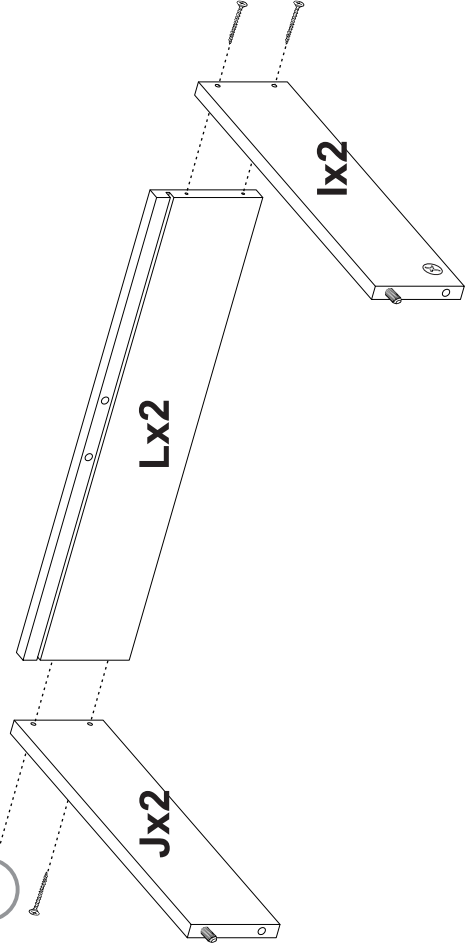

Lx2

Jx2

Ix2

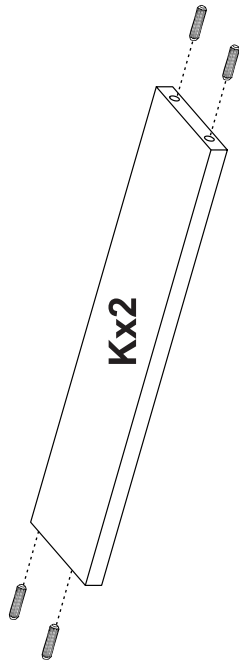

HERRAJES PARA ARMADO
ASSEMBLY HARDWARE

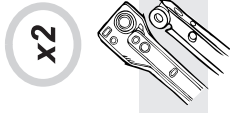

x2

Riel /
Drawer Slides

x56



Puntilla 1"/
Nail

x26



Tapa Adhesiva
Minifix /
Cover Caps

x4



Soporte Tubo
Ovalado/
Rod Support

x2

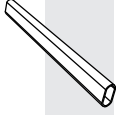

Tubo Ovalado/
Rod

x96



Tornillo Lamina/
Sheet Metal Screw

x2



Perfil en H
/ H profile

x2

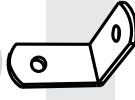

Cantонера/
Angle Brace

x2

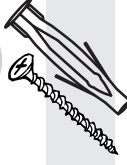

Chazo Plástico +
Tornillo de Ensamble/
Plastic Wall Anchor +
Drywall Screw



TENER PRECAUCIÓN AL ABRIR LA BOLSA DE HERRAJES PARA NO EXTRAIAR NINGUNO. COMPROBE QUE EL CONTENIDO DE LAS PIEZAS SEA EL CORRECTO. EN CASO QUE FALTE ALGUNA PIEZA O ESTÉ DEFECTUOSA DEVUELVA LAS PIEZAS AL ALMACÉN CON SU FACTURA PARA EFECTUAR EL CAMBIO DE LAS PIEZAS Y/O LOS HERRAJES LO MÁS PRONTO POSIBLE. / PLEASE BE CAUTIOUS WHEN OPENING THE HARDWARE BAG TO NOT LOSE ANY. CHECK THE CONTENTS OF THE PARTS ARE CORRECT. IF ANY PART IS MISSING OR IMPERFECT PLEASE RETURN THE PARTS TO THE STORE WITH THE PRODUCT INVOICE ATTACHED TO MAKE EFFECTIVE THE REPLACEMENT OF THE IMPERFECT PIECES OR HARDWARE AS SOON AS POSSIBLE.

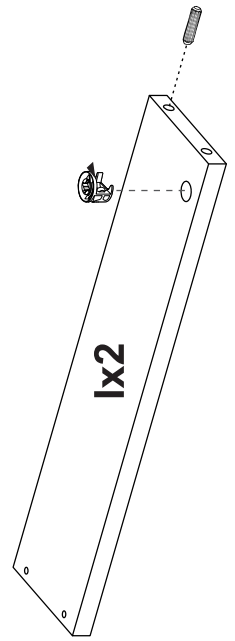
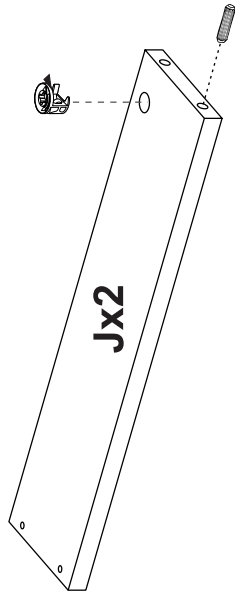

**PIEZAS DE ARMADO
ASSEMBLY PARTS**

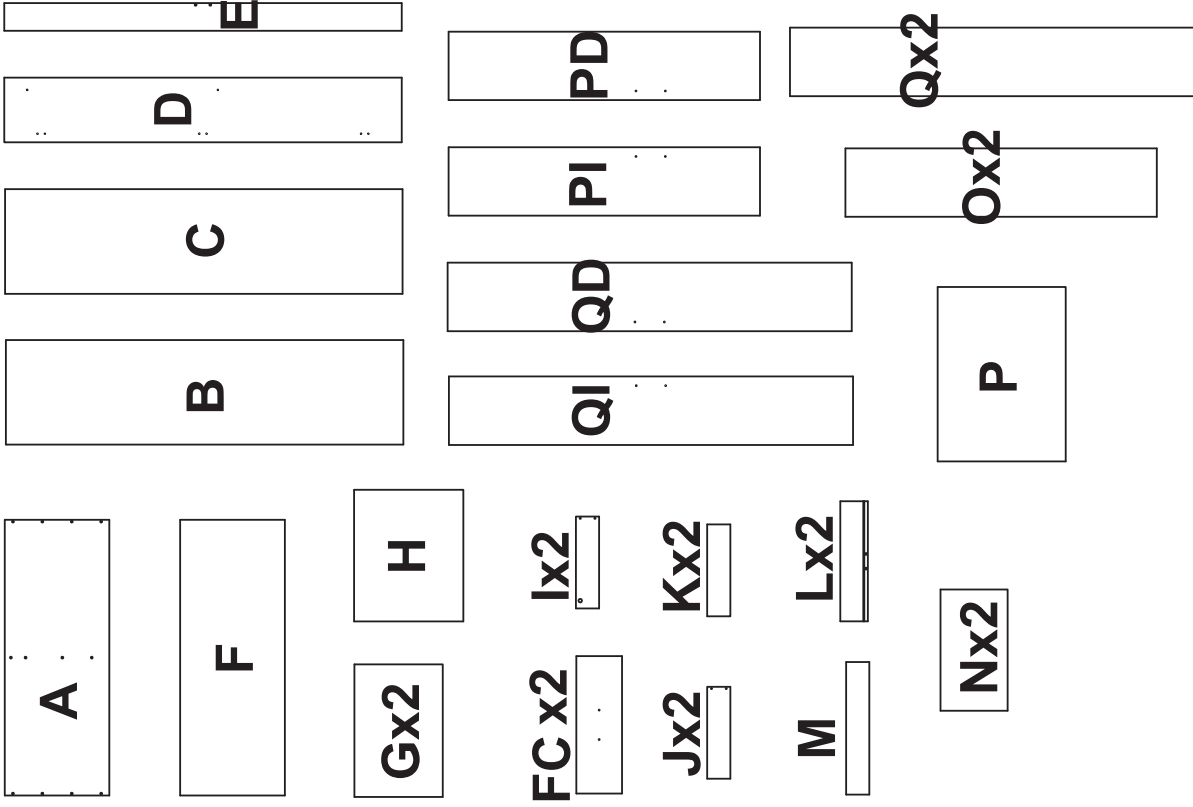

**INSTALACIÓN BISAGRAS/
HINGES INSTALLATION**

13

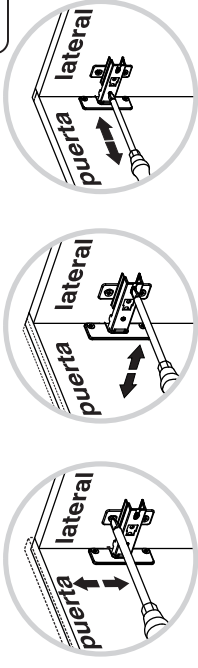

Bisagra Semi
Parche/
Half Overlay Hinge

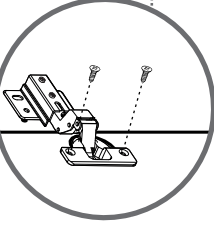

Bisagra Parche/
Full Overlay Hinge

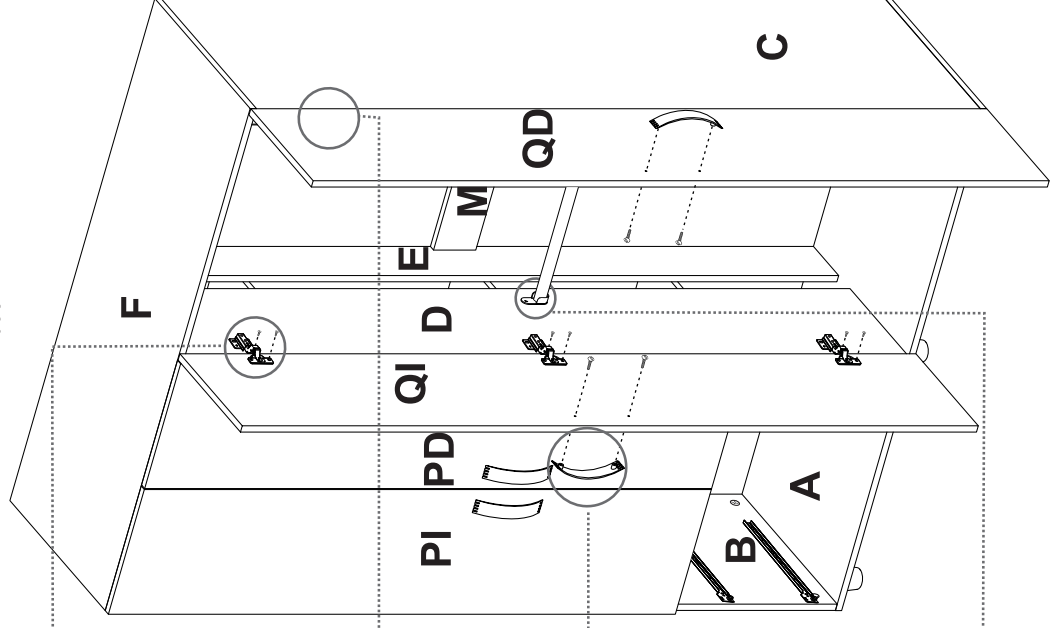
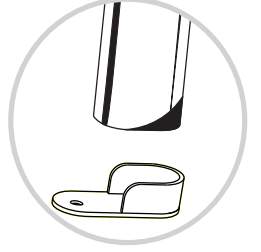
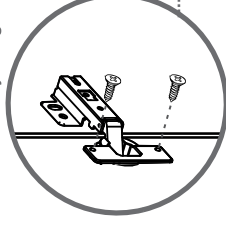

ANTES DE EMPEZAR A ARMAR EL MUEBLE LEA DETENIDAMENTE LAS INSTRUCCIONES. SE RECOMIENDA ARMAR EL MUEBLE SOBRE LA CAJA O SOBRE UNA SUPERFICIE LISA Y CUBIERTA, PARA NO RAYARLO / BEFORE STARTING TO ASSEMBLE THE CABINET, CAREFULLY READ THE INSTRUCTIONS. IT'S RECOMMENDED TO ASSEMBLE THE CABINET ON THE BOX OR ON A FLAT AND COVERED SURFACE IN ORDER TO NOT SCRATCH THE PRODUCT.



Bisagra Semi
Parche/
Half Overlay Hinge

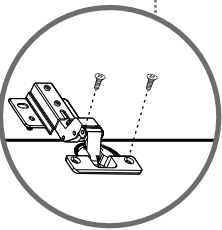

Bisagra Parche/
Full Overlay Hinge

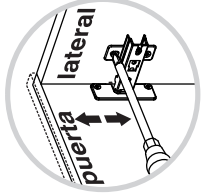
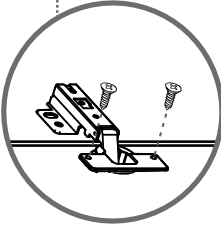

AJUSTE DE ALTURA
/ HEIGHT
ADJUSTMENT

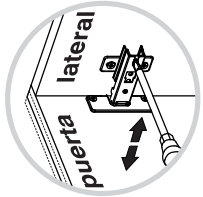

AJUSTE DE PROFUNDIDAD
/ DEPTH
ADJUSTMENT

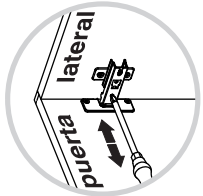

AJUSTE LATERAL
/ LATERAL
ADJUSTMENT

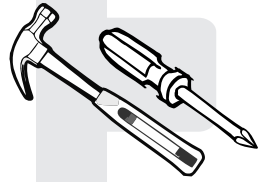
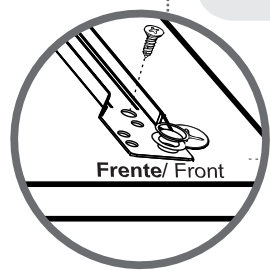
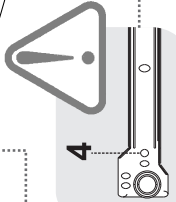
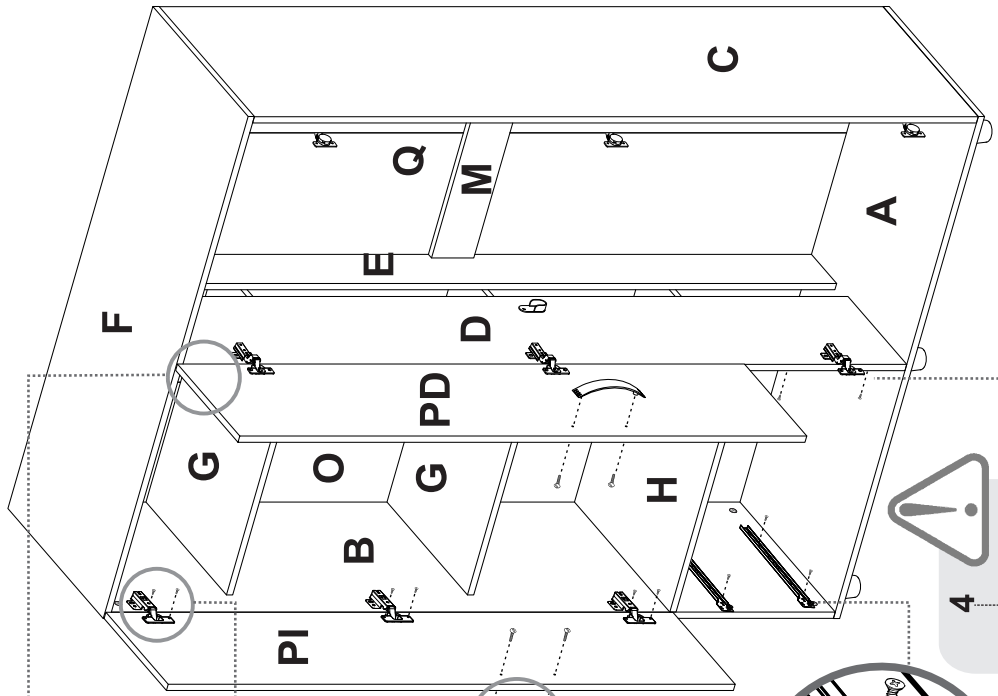

*(Herramientas NO incluidas) *Tools NOT Included

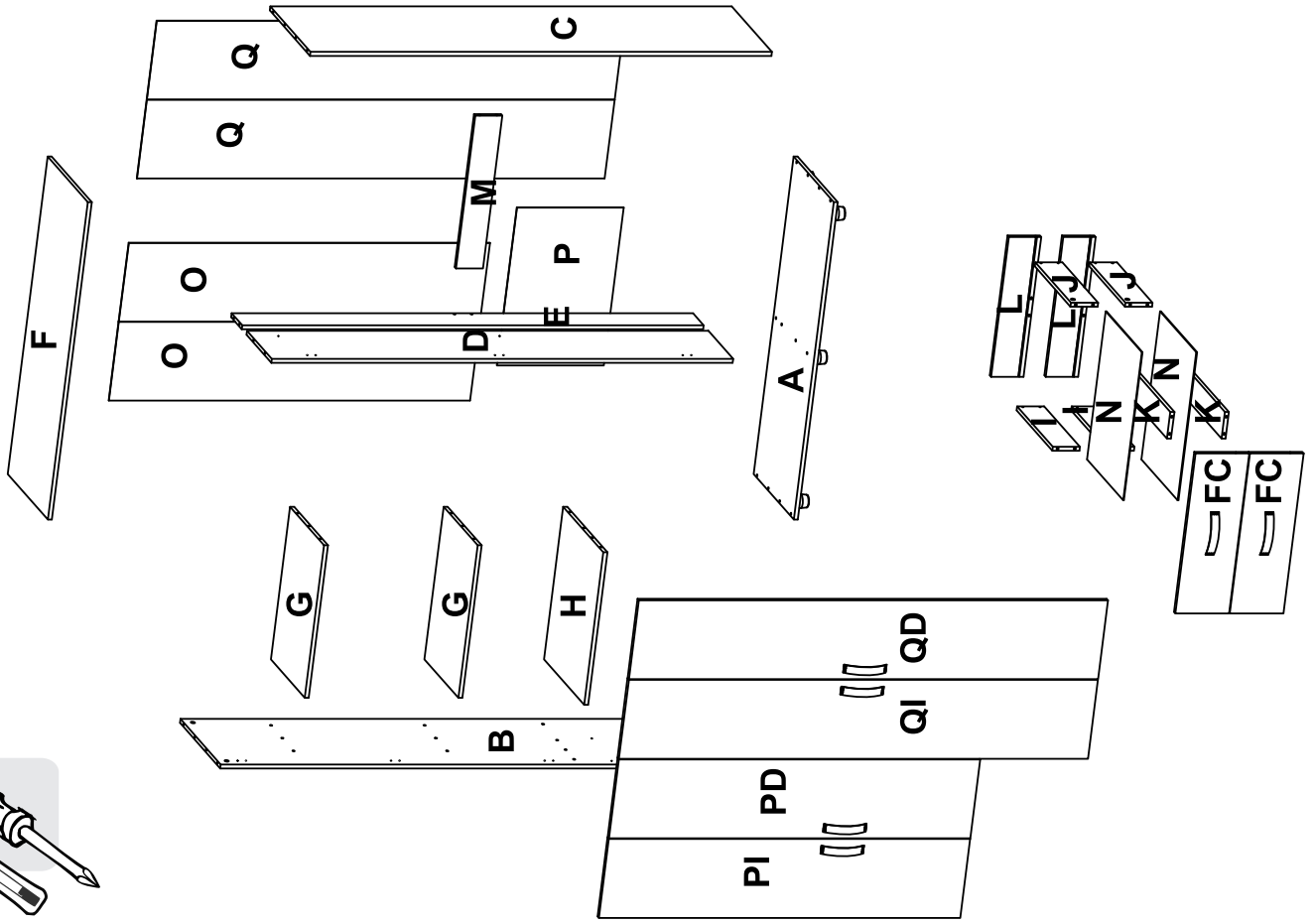

1



SE RECOMIENDA ARMAR EL MUEBLE ENTRE DOS PERSONAS /
IT IS RECOMMENDED TO ASSEMBLE THE PRODUCT BETWEEN TWO PEOPLE

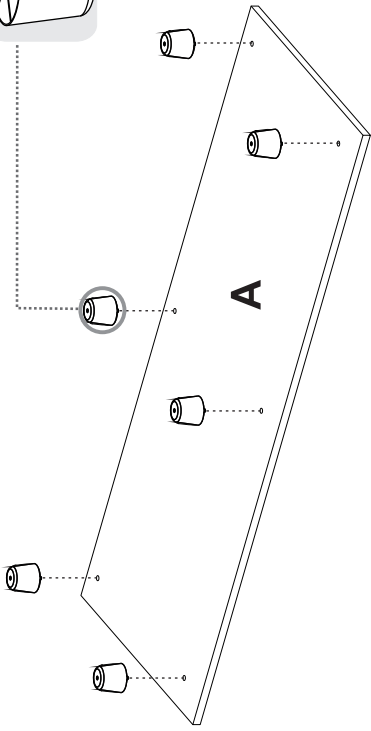
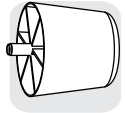

**VOLTEAR
TURN OVER**

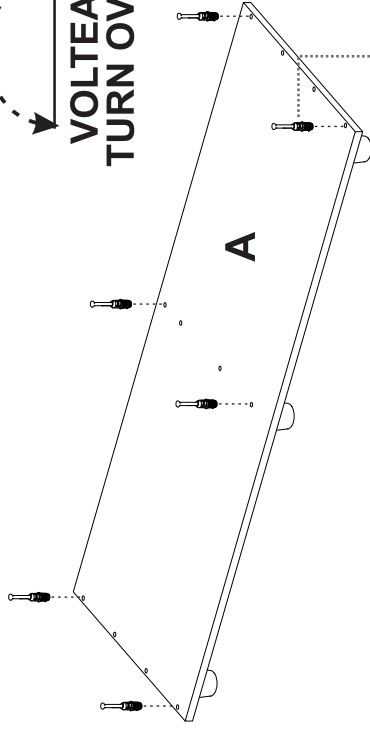

2

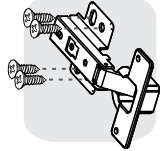
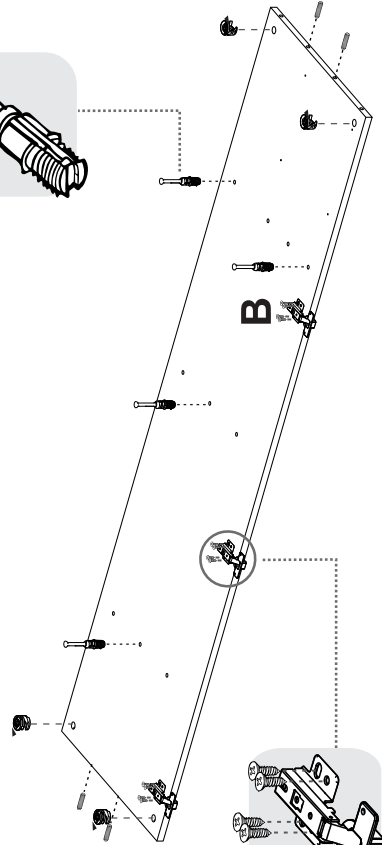
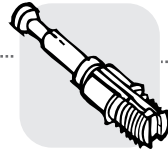

**Bisagra parche/
Full overlay hinge**

11

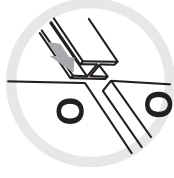

**Perfil en H/
H Profile**

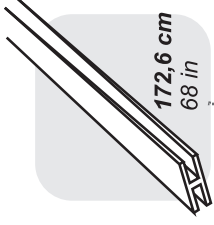

172,6 cm
68 in

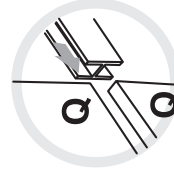

**Perfil en H/
H Profile**

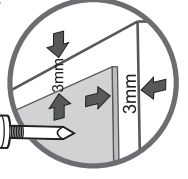
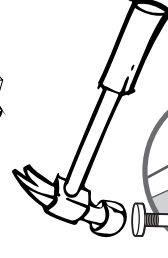
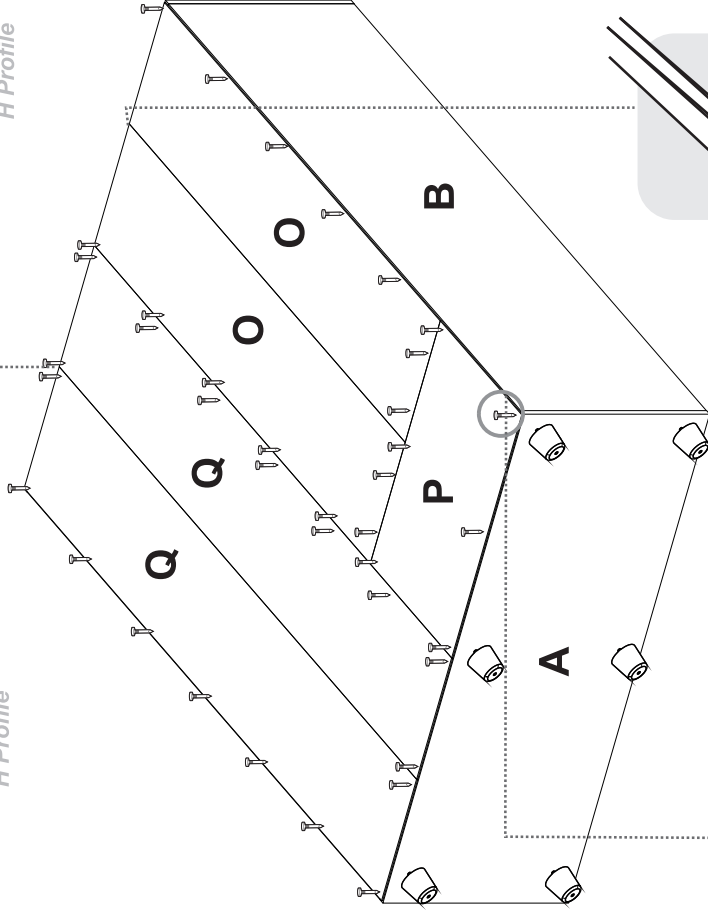

3

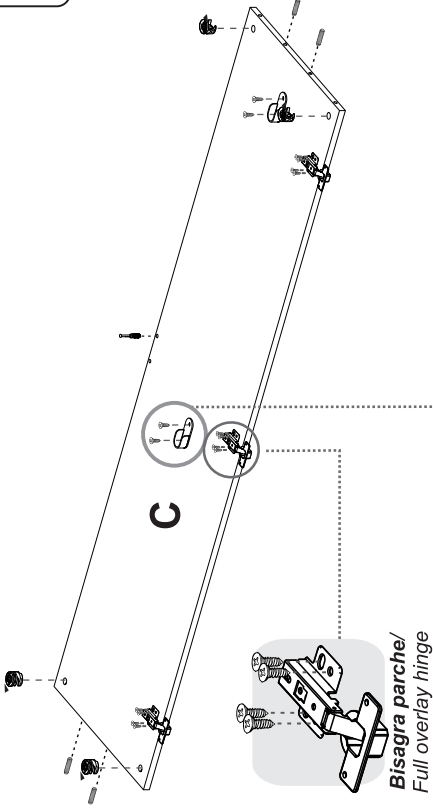

4

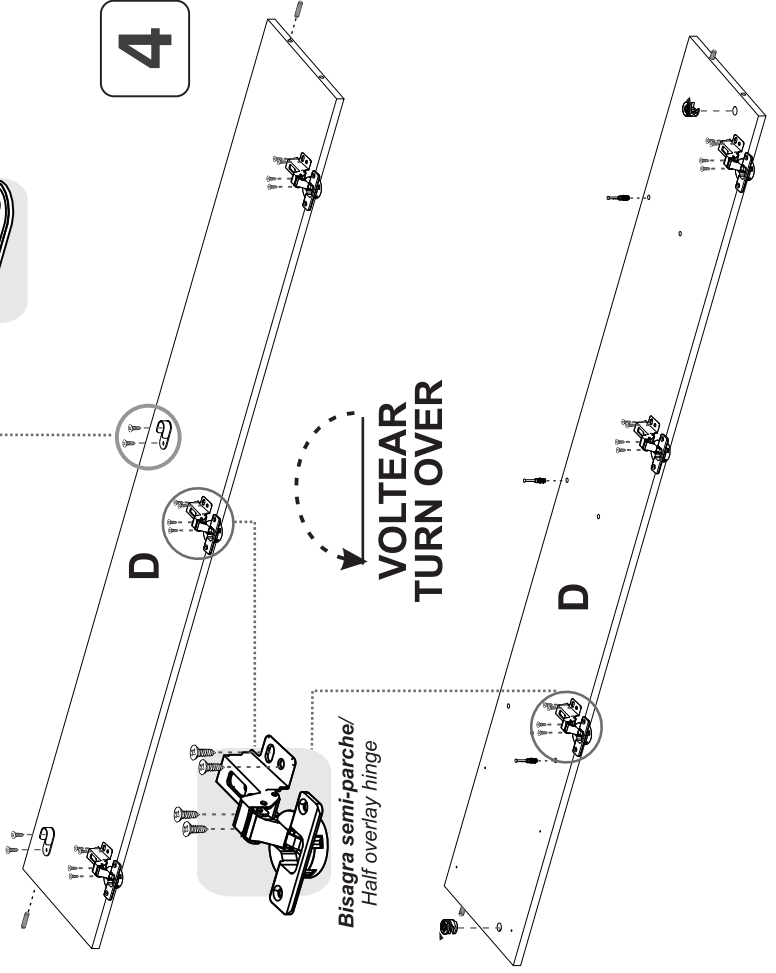

9

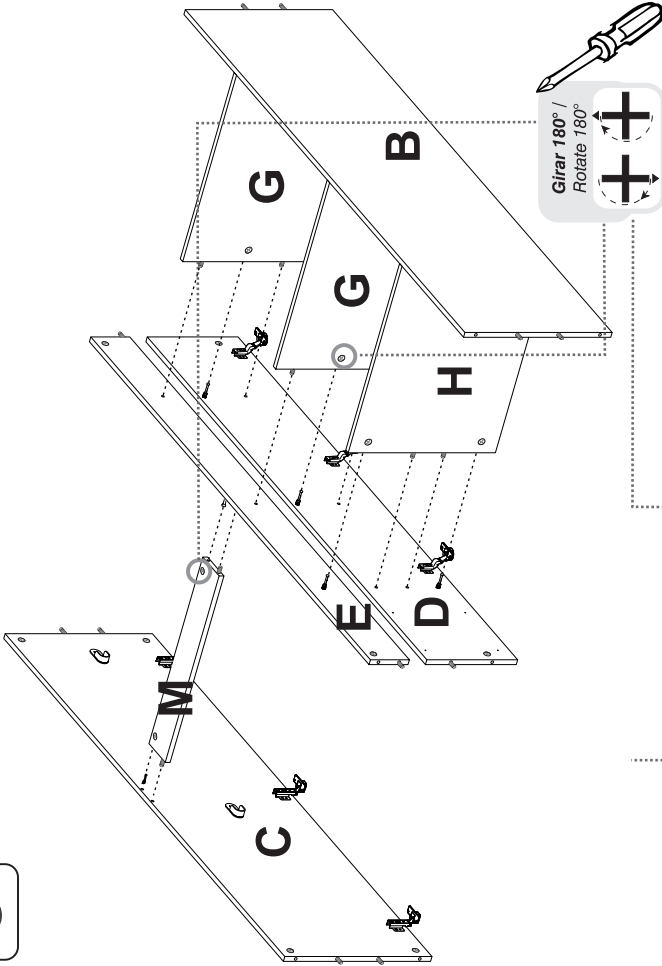

10

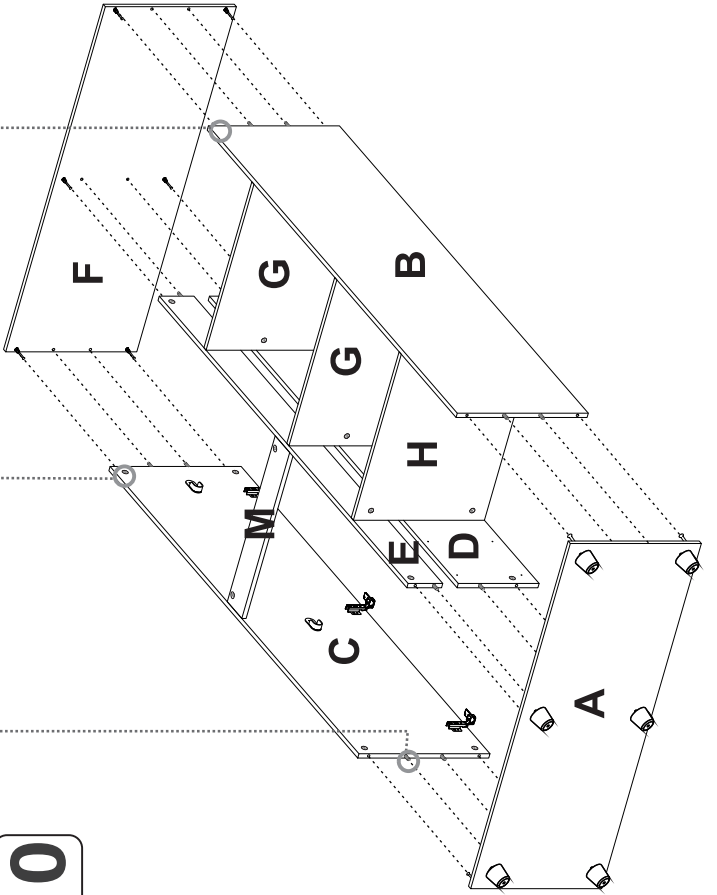

7

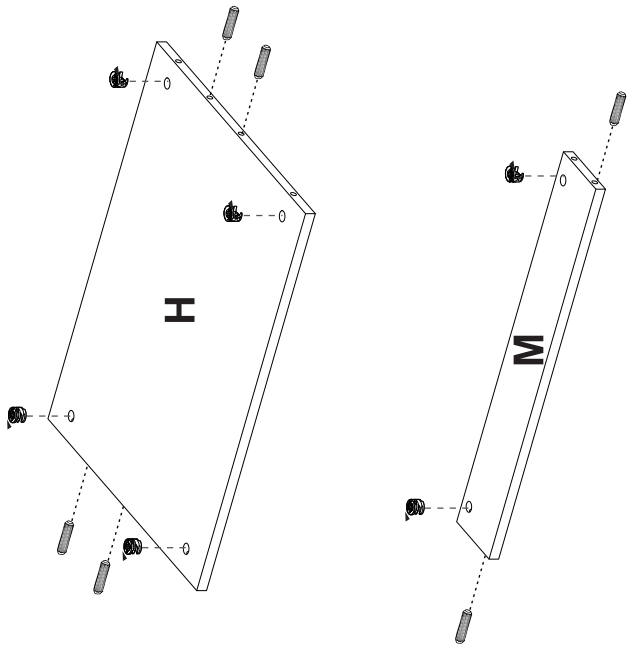

8

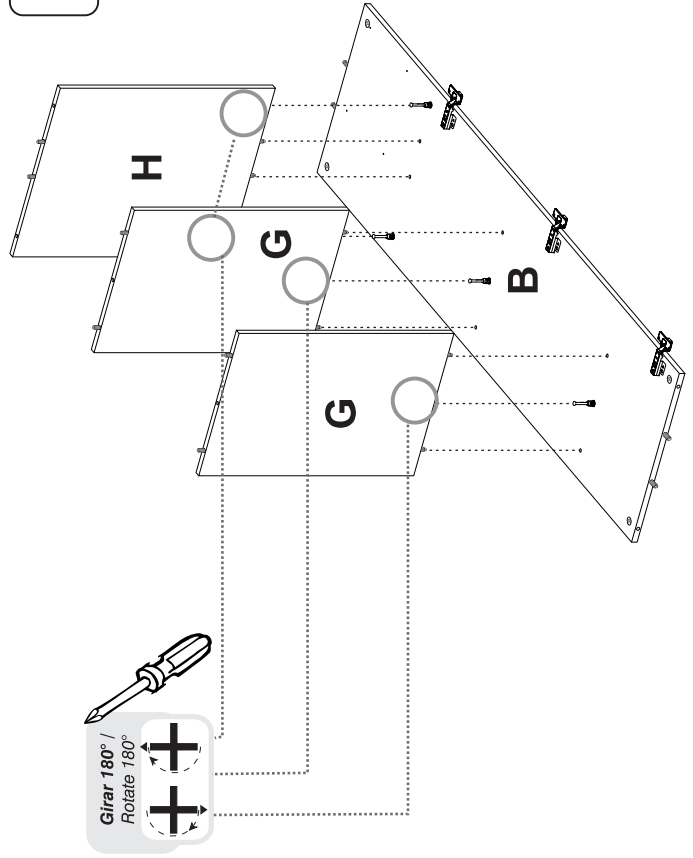

5

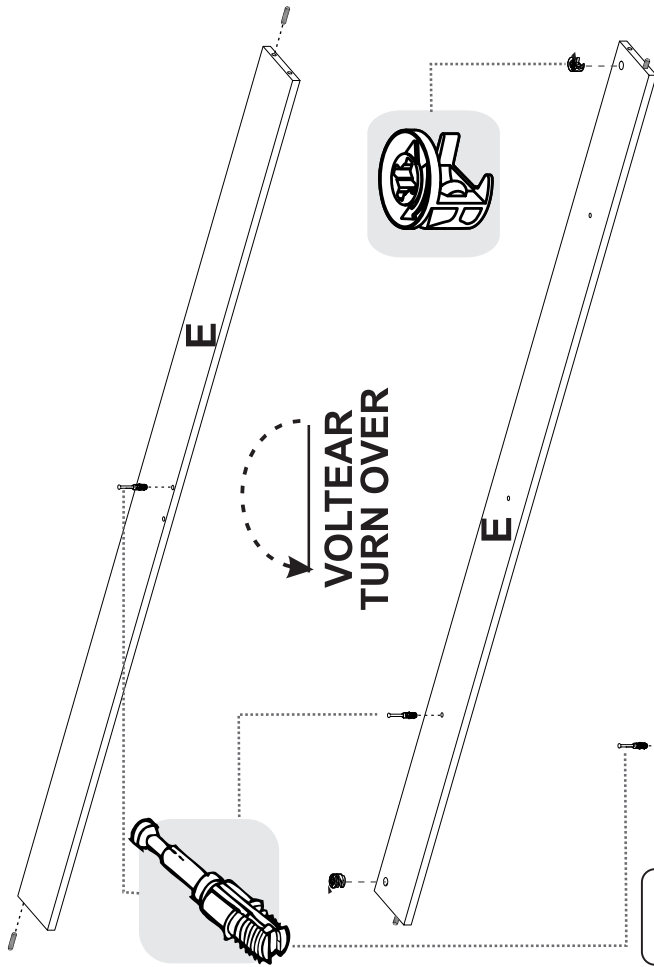

6

