

Deslice los cajones dentro del mueble / Slide the drawers inside the cabinet

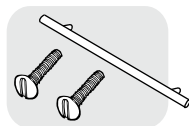

Al finalizar el ajuste, cubra las cajas con las tapas adhesivas / After tightening all the panels, cover the minifix cams with the adhesive caps.



Al terminar de armar, despegue los adhesivos (en caso de que queden residuos de pegamento, limpie la superficie con alcohol) / After finishing the assembly, take off the adhesives. (In case of glue residues, wipe them with alcohol)



Alto/ Height: 184 cm / 72,44 in
Ancho/ Width: 181 cm / 71,26 in
Fondo/ Depth: 50,5 cm / 19,88 in

LOTE No: _____

REF./SKU. CLW3615

By: **RTA**®
m u e b l e s
TEL (572) 691 17 00
PBX (572) 695 91 81
CALI - COLOMBIA
www.rta.com.co

CLOSET HARLEM
/Harlem Wardrobe

RECOMENDACIONES IMPORTANTES KEY RECOMMENDATIONS

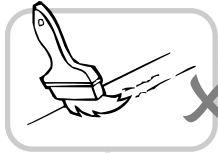

NO pinte el mueble /
Do not paint the
furniture.



NO mojar o ubicar
a la intemperie /
Do not expose to rain
or direct sun.

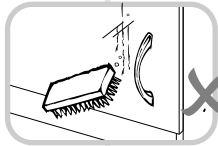
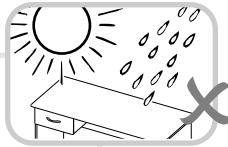

NO lavar las manijas o
tiraderas con jabones o
elementos abrasivos /
Do not wash handles or
knobs with soap or
abrasives.

NO sobrecargue el mueble.
no exceda el peso de 30 kilos
para gabinetes de cocina /
Do not overload the cabinet.
Weight max. 66lbs
for kitchen cabinets.

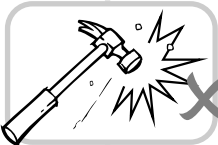

NO golpear ni martillar
el mueble (hágalo sólo
donde se indique) /
Do not hit or hammer
the furniture (just do it
where is indicated).

NO permita que los niños
manipulen el mueble, puede
voltearse y lastimarlos /
Do not allow children to
handle the cabinets or
drawers, they could get hurt.

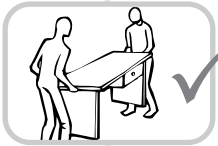
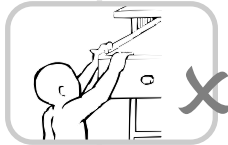

SIEMPRE levante el
mueble entre dos
personas, NO lo arrastre /
Do not drag the furniture.
Lift it between two people.

Limpie con paño seco,
/ Clean with a dry cloth.



HERRAJES BÁSICOS PARA MUEBLES RTA BASIC HARDWARE FOR RTA FURNITURE

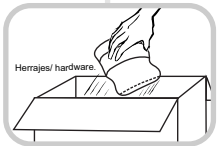

1. Abrir la caja del mueble
y buscar la bolsa con los
herrajes / Open the box
and look for the hardware
bag.

3. Separe los herrajes para
facilitar su identificación
durante el armado /
Separate hardware for easy
identification during
assembly.

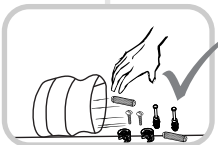
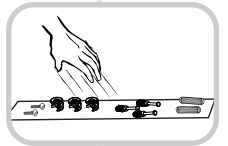

2. Abrir el paquete y
comprobar que el
contenido de las piezas es
correcto / Open the
package and verify that
the content of the pieces
is correct.

4. Arme el mueble en un lugar
limpio y en una superficie
plana / RTA furniture
must be assembled
in a clean place and on
a flat surface.

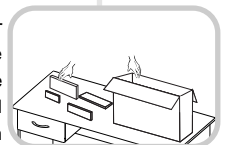

RTA
muebles

19

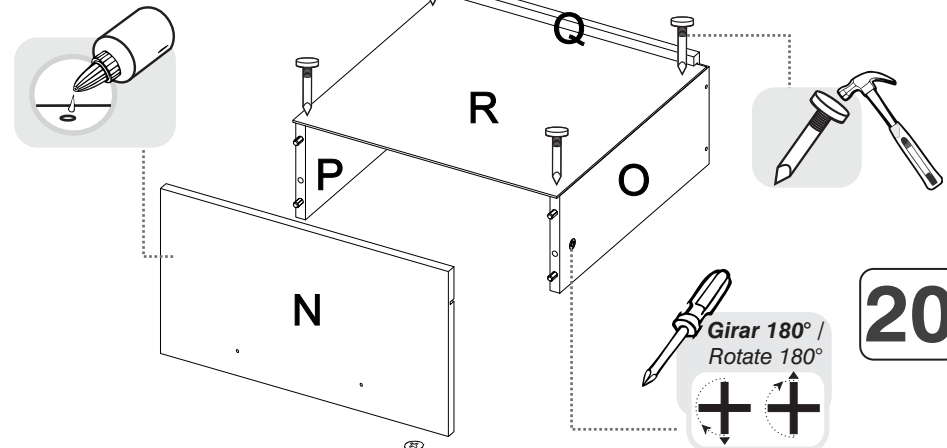
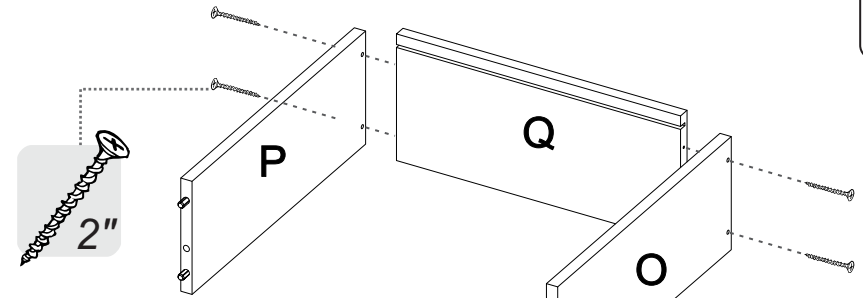

20

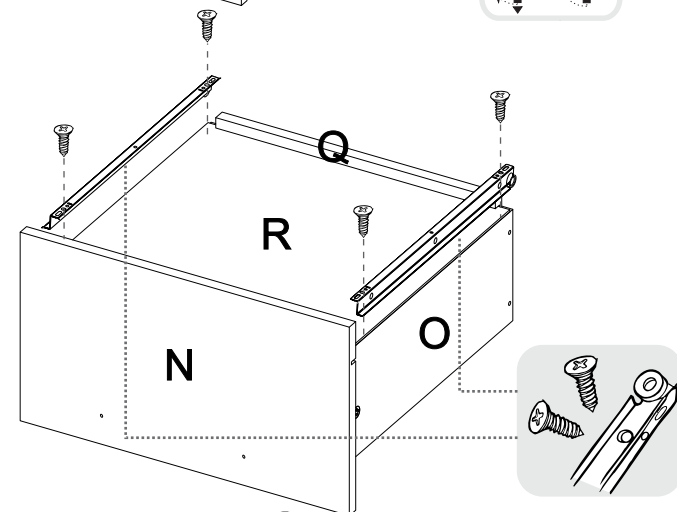

REPETIR ESTOS PASOS PARA LOS OTROS CAJONES /
REPEAT THIS STEPS FOR THE OTHER DRAWERS



17

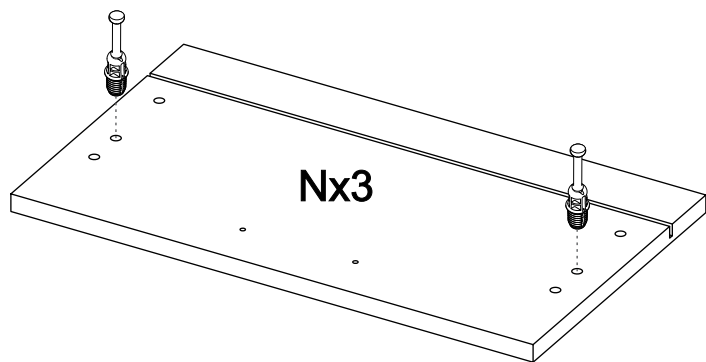

18

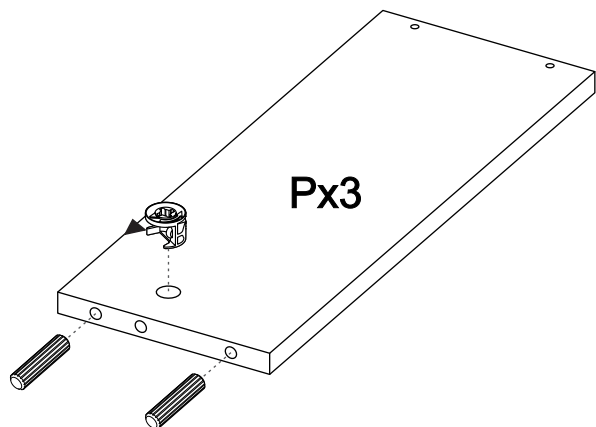
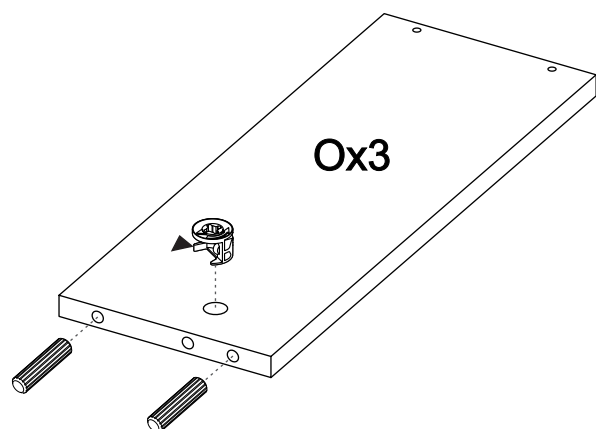

RECOMENDACIONES DE ENSAMBLE / ASSEMBLY RECOMMENDATIONS

El buen funcionamiento del mueble depende de un adecuado ensamblaje
An excellent furniture's performance relies on a solid and a suitable assembly.

MINIFIX / CONNECTOR - DOWELS

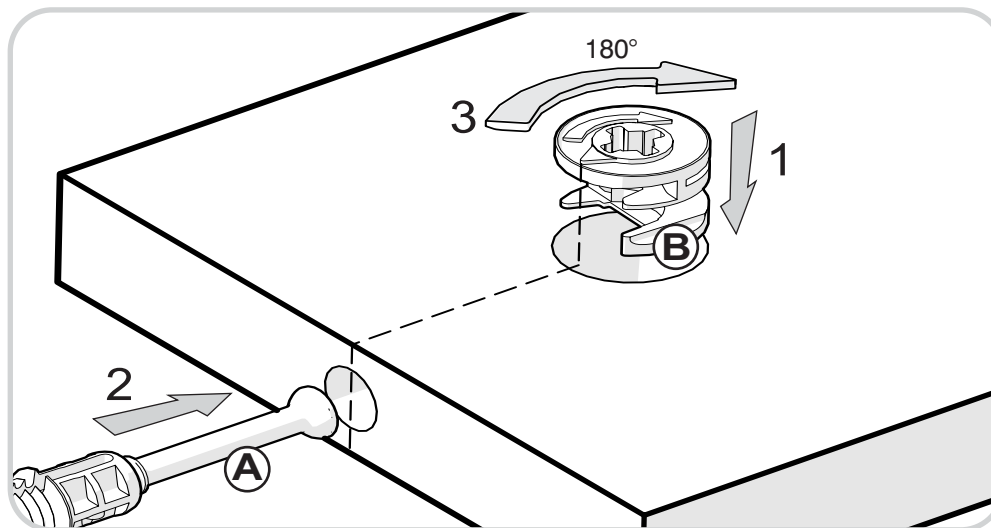

Sistema de unión compuesto por un perno (A) y una caja minifix (B).

(1) Se inserta la caja minifix dentro de la perforación ubicada en la cara de la pieza, la flecha debe apuntar siempre a la dirección de la perforación por donde entrará el perno.

(2) Se debe insertar el perno por su parte plástica en las perforaciones que se indiquen, luego se inserta la punta metálica en la perforación para que su cabeza quede al interior de la caja minifix.

(3) Girar la caja minifix 180° para apretar las dos piezas.

It's a fitting system made of a spreading bolt (A) and a minifix cam (B).

(1) Insert the minifix cam in the hole placed in the face of the panel with the arrow pointing towards the hole where the bolt will fit.

(2) Insert the bolt with its plastic base in the shown holes, then insert the metallic bolt head in the holes so it fits inside the minifix cam.

(3) Tight the panels by turning the minifix cam 180°.

TARUGOS O TAQUETES / FLUTED DOWEL PIN

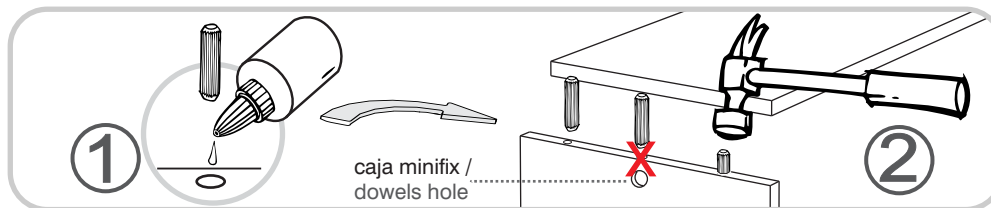

Es un pedazo de madera corto y grueso, de aproximadamente 3 a 10 cm de largo, que sirve para amarrar el mueble y darle resistencia. Tenga en cuenta que debe aplicar una gota de pegamento en cada perforación en la que se pondrá el taquete.

It's a short and thick piece of wood, 1,2 to 3,9 inches approximately, which is used to tie the cabinet and give it resistance. Take into account to apply a drop of glue on each hole you will insert the fluted dowel pin.

RECOMENDACIONES IMPORTANTES / KEY RECOMMENDATIONS

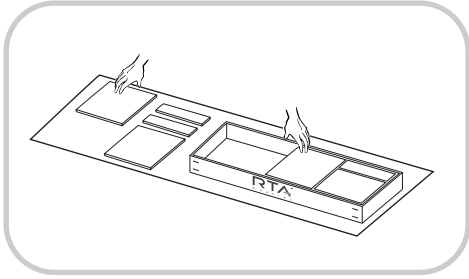

Se recomienda armar el mueble sobre la caja o una superficie lisa para no rayarlo. It is recommended to assemble the product on the box or on a flat surface to not scratch it.

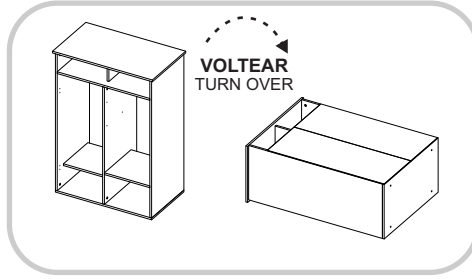

Voltear el mueble cuidadosamente para ensamblar los fondos. Carefully turn over the cabinet to assemble the back panels.

PESO MAX. SUGERIDO EN MUEBLE (Kg) / MAX SUGGESTED LOAD (Kg)

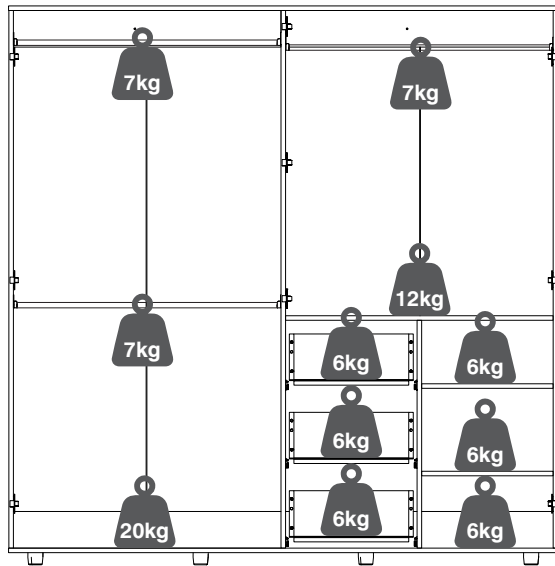

NOTA: La resistencia a las cargas puede variar dependiendo si es una carga distribuida o una carga puntual, las gráficas corresponden a cargas puntuales, NO exceder los pesos sugeridos / **NOTE:** The load capacity depends if it is a *point load* or if it is an *uniform distributed load*, do not exceed the suggested loads.

INSTALACIÓN DE LAS PUERTAS DOOR INSTALLATION

16

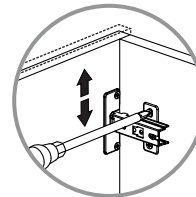
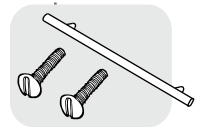
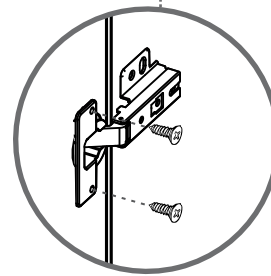
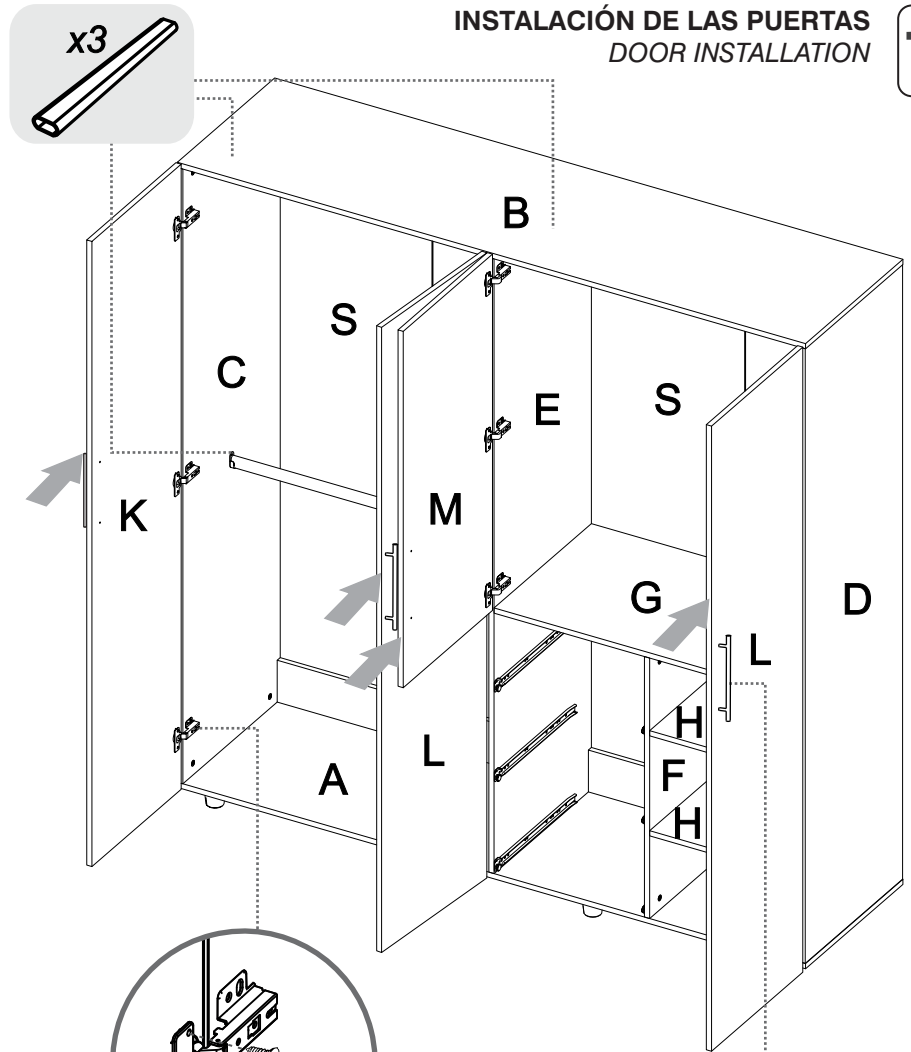

AJUSTE DE ALTURA
| HEIGHT
ADJUSTMENT

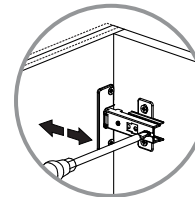

AJUSTE DE PROFUNDIDAD
| DEPTH
ADJUSTMENT

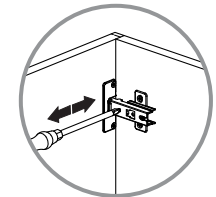

AJUSTE LATERAL
| LATERAL
ADJUSTMENT

15



PARA INSTALAR A PARED
WALL INSTALLATION

VOLTEAR EL MUEBLE CUIDADOSAMENTE
/ CAREFULLY FLIP THE CABINET



* Herramientas
NO incluidas/
Tools not
included



Utilizar una broca
de 5/16" para hacer
las perforaciones
en el muro/
Use a 5/16" drill bit
to drill the wall.

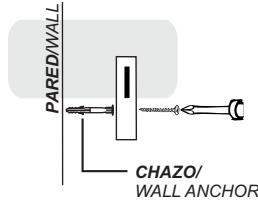

Tornillo 2 1/2" +
Chazo Mariposa/
Wall Anchor

PARED/WALL
VISTA FRONTAL / FRONT VIEW

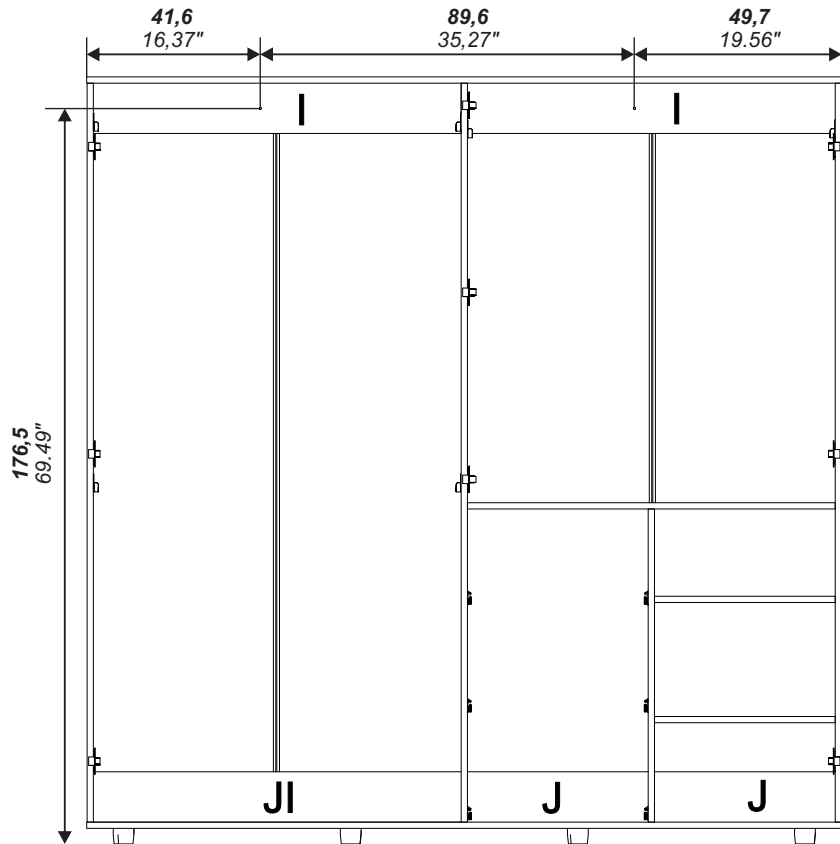

* Centímetros / Inches

HERRAJES PARA ARMADO
ASSEMBLY HARDWARE

x63

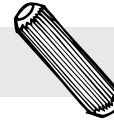

Tarugo/
Fluted Dowel Pin

x52



Perno minifix/
Spreading Bolt

x52



Minifix/
Minifix Cams

x54



Tapa Adhesiva
Minifix/
Cover Caps

x7

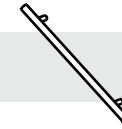

Manija/
Handle

x8



Deslizador
Plástico/
Plastic Leg

x6

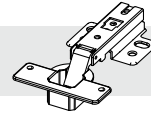

Bisagra Parche/
Full overlay
Hinge

x6

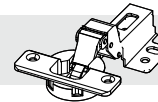

Bisagra
Semiparche/
Half overlay Hinge

x70



Puntilla/
Nail

x108



Tornillo Lámina/
Sheet Screw

x12



Tornillo de
Ensamble 2"/
2" Drywall Screw

x3

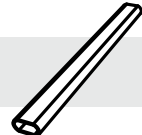

Tubo ovalado/
Closet Rod

x2



Perfil en H/
H profile

x2



Chazo Mariposa +
Tornillo ensamble
2" 1/2 / Plastic wall
anchor +2" 1/2
Drywall screw

x6



Soporte Tubo/
Closet Rod
Support

x3



Riel /
Drawer Slides

x3



Pegante/
Glue

x14



Tornillo Manija/
Handle Screw



TENER PRECAUCIÓN AL ABRIR LA BOLSA DE HERRAJES PARA NO EXTRAIAR NINGUNO. COMPRUEBE QUE EL CONTENIDO DE LAS PIEZAS SEA EL CORRECTO. EN CASO QUE FALTE ALGUNA PIEZA O ESTE DEFECTUOSA DEVUELVA LAS PIEZAS AL ALMACÉN CON SU FACTURA PARA EFECTUAR EL CAMBIO DE LAS PIEZAS Y/O LOS HERRAJES LO MÁS PRONTO POSIBLE. / PLEASE BE CAUTIOUS WHEN OPENING THE HARDWARE BAG TO NOT LOSE ANY. CHECK THE CONTENTS OF THE PARTS ARE CORRECT. IF ANY PART IS MISSING OR IMPERFECT PLEASE RETURN THE PARTS TO THE STORE WITH THE PRODUCT INVOICE ATTACHED TO MAKE EFECTIVE THE REPLACEMENT OF THE IMPERFECT PIECES OR HARDWARE AS SOON AS POSSIBLE.

PIEZAS DE ARMADO ASSEMBLY PARTS

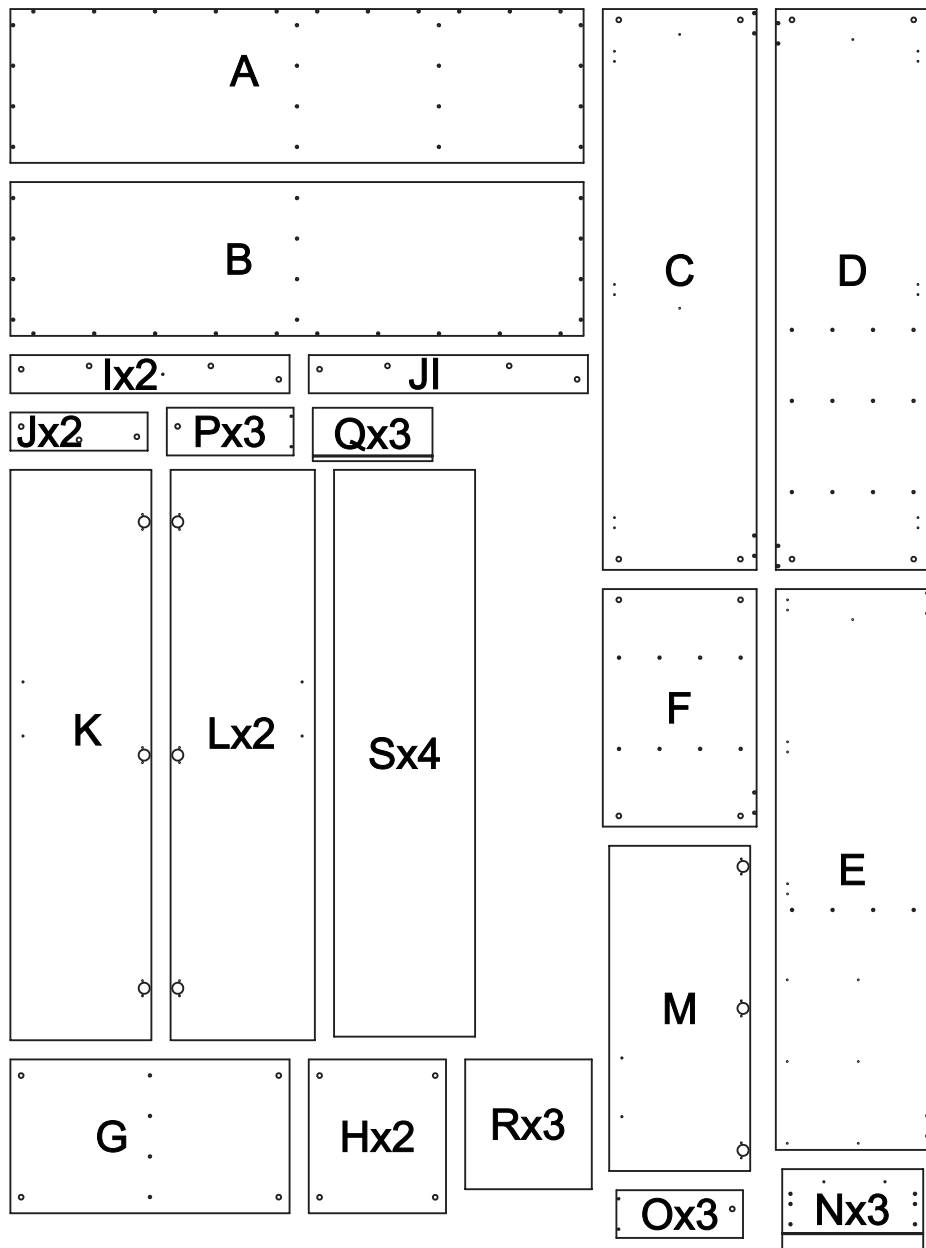

VOLTEAR EL MUEBLE CUIDADOSAMENTE
/ CAREFULLY FLIP THE CABINET



14

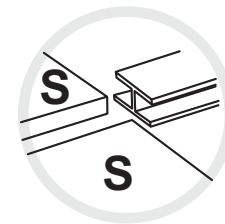

perfil en "H" (x2)

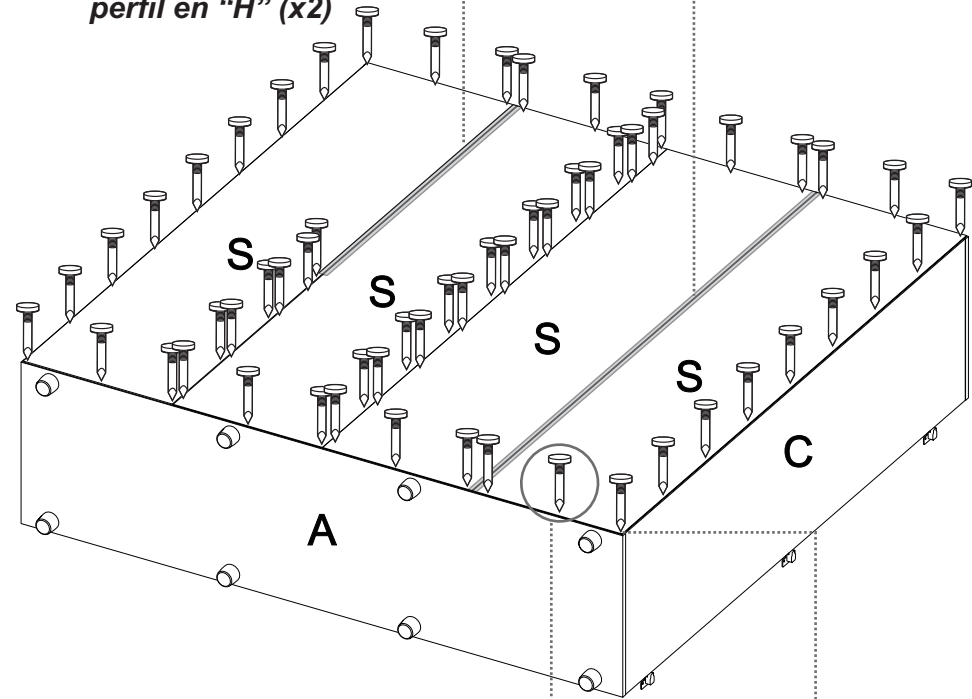

x58

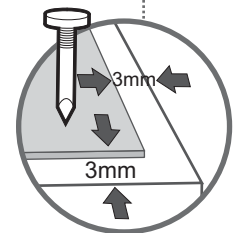

ANTES DE EMPEZAR A ARMAR EL MUEBLE LEA DETENIDAMENTE LAS INSTRUCCIONES. SE RECOMIENDA ARMAR EL MUEBLE SOBRE LA CAJA O SOBRE UNA SUPERFICIE LISA Y CUBIERTA, PARA NO RAYARLO / BEFORE STARTING TO ASSEMBLE THE CABINET, CAREFULLY READ THE INSTRUCTIONS. IT IS RECOMMENDED TO ASSEMBLE THE FURNITURE ON THE BOX OR ON A FLAT AND COVERED SURFACE IN ORDER TO NOT SCRATCH THE PRODUCT.

Girar 180° /
Rotate 180°

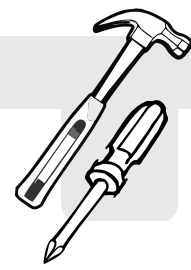
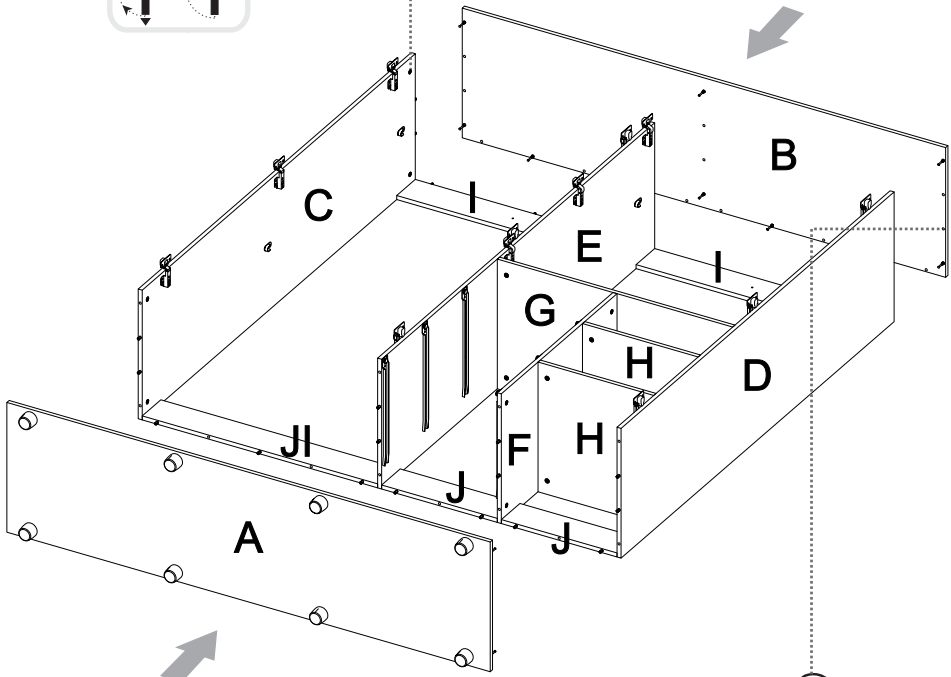
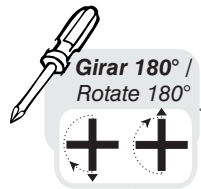

*(Herramientas NO incluidas) *Tools NOT Included

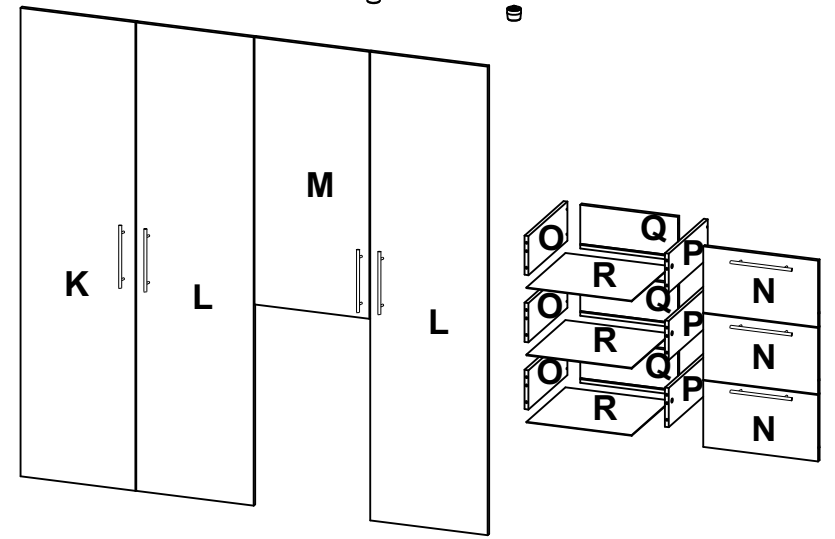
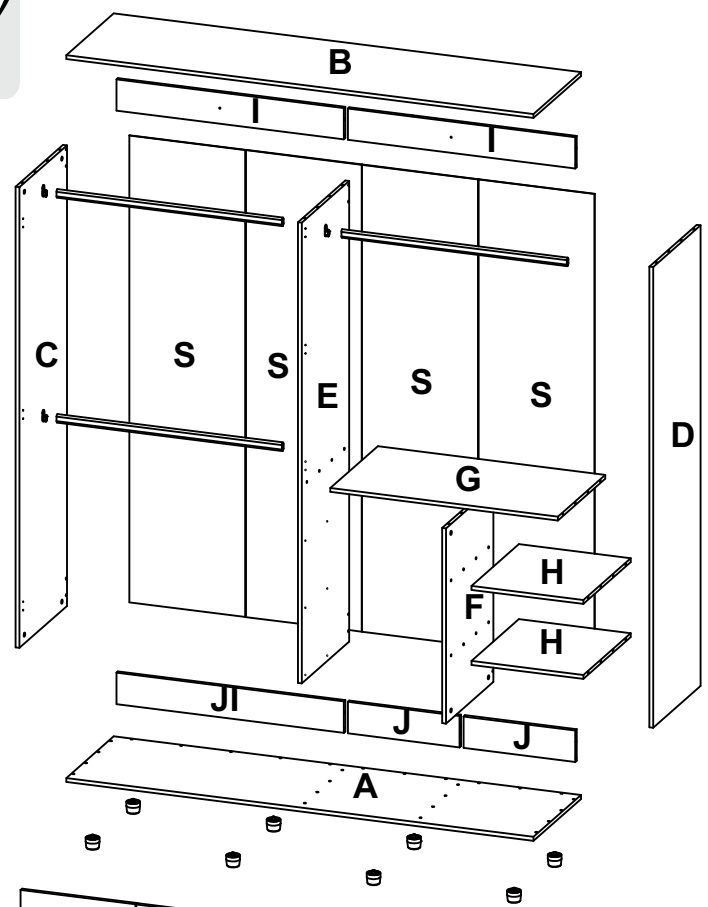

1

SE RECOMIENDA ARMAR EL MUEBLE ENTRE DOS PERSONAS / IT IS RECOMMENDED TO ASSEMBLE THE PRODUCT BETWEEN TWO PEOPLE

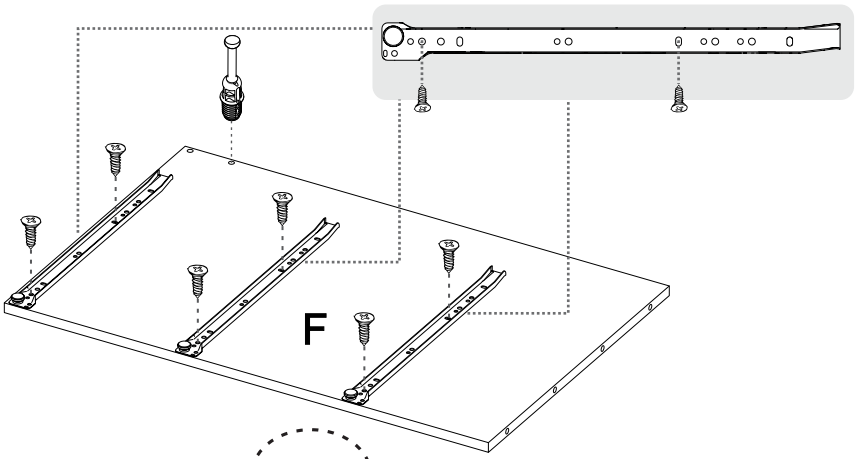

VOLTEAR
TURN OVER

2

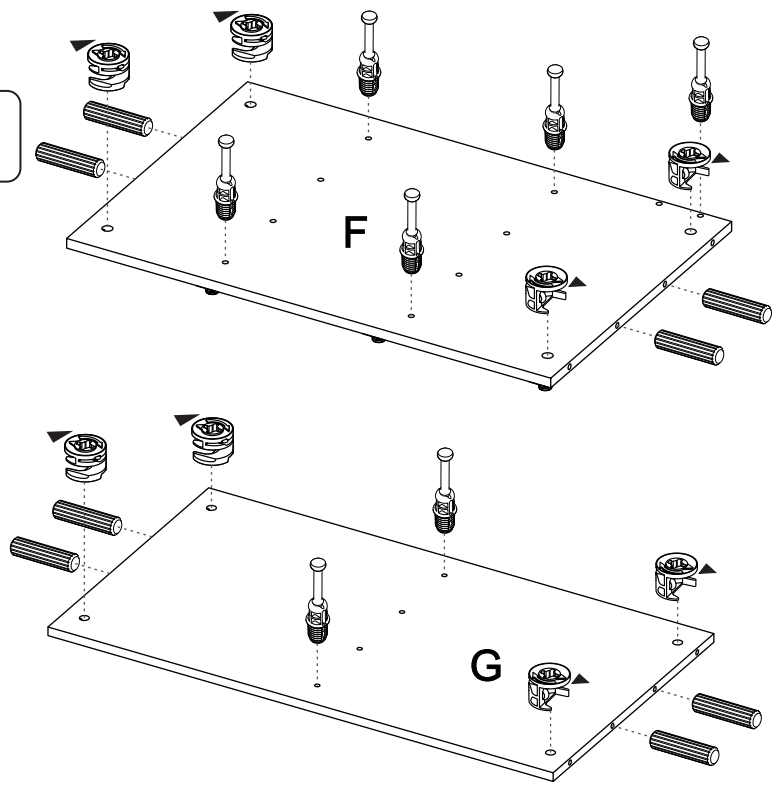

11

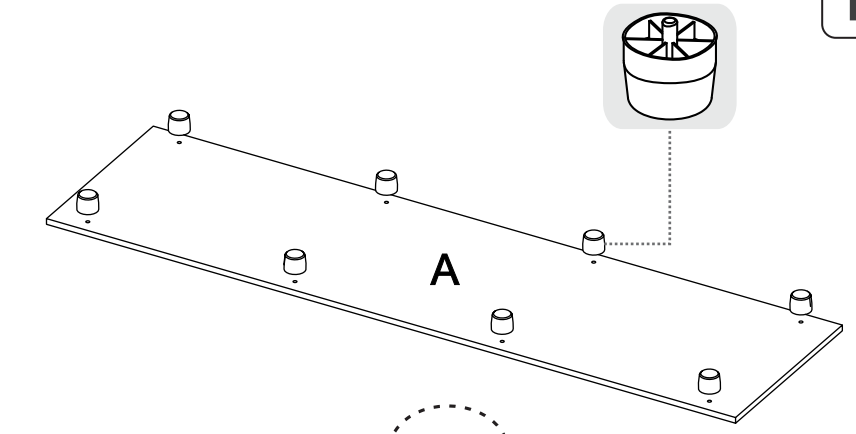

VOLTEAR
TURN OVER

12

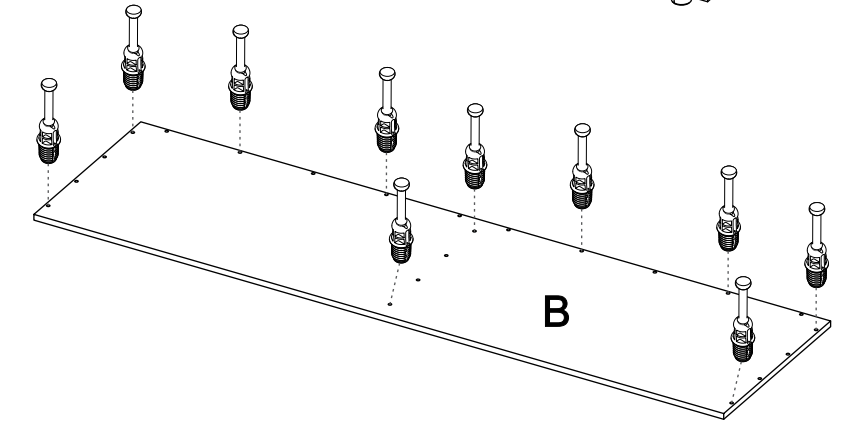
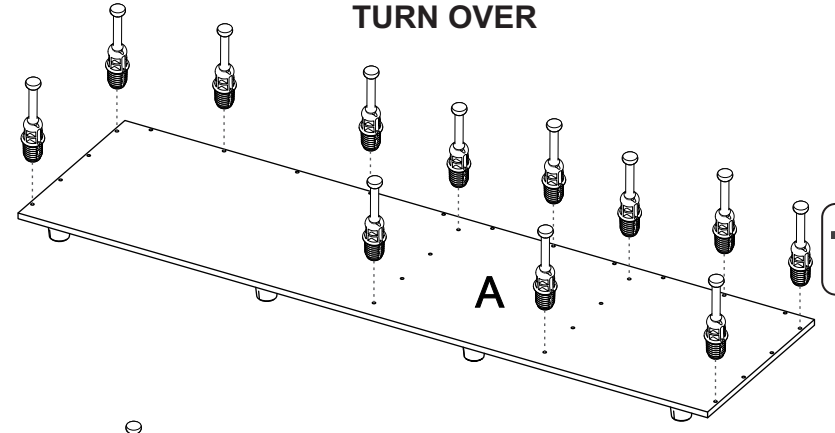

9

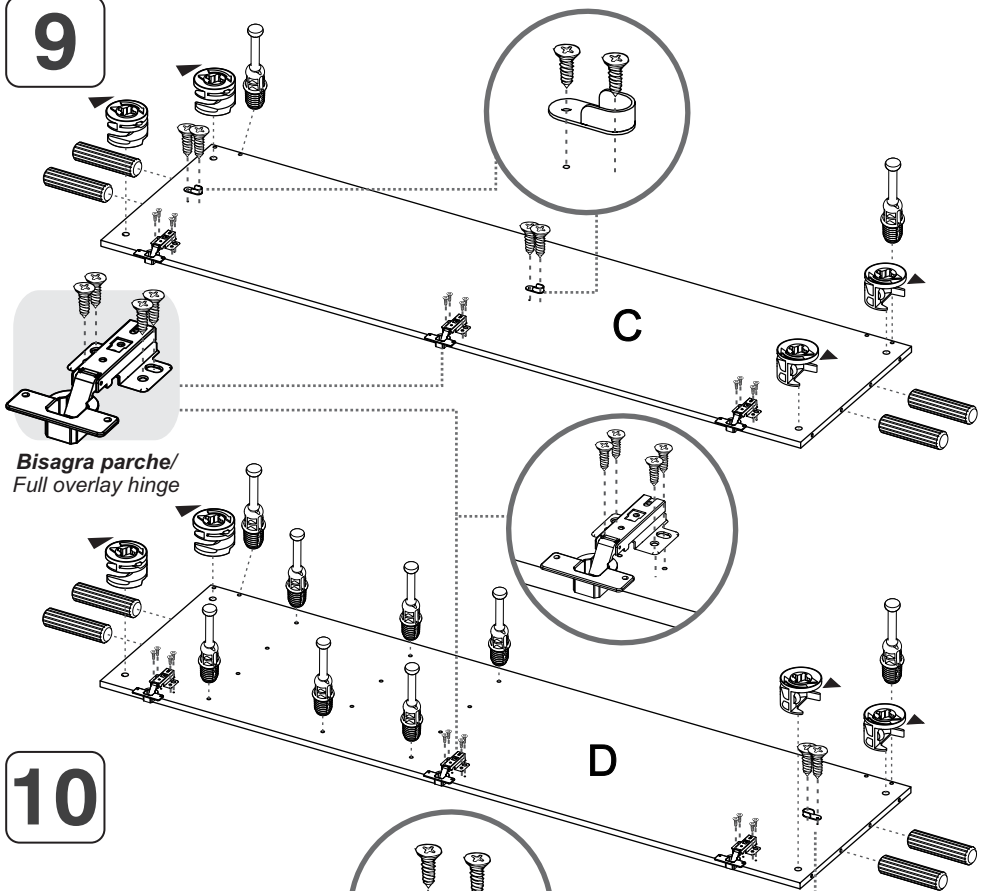

10

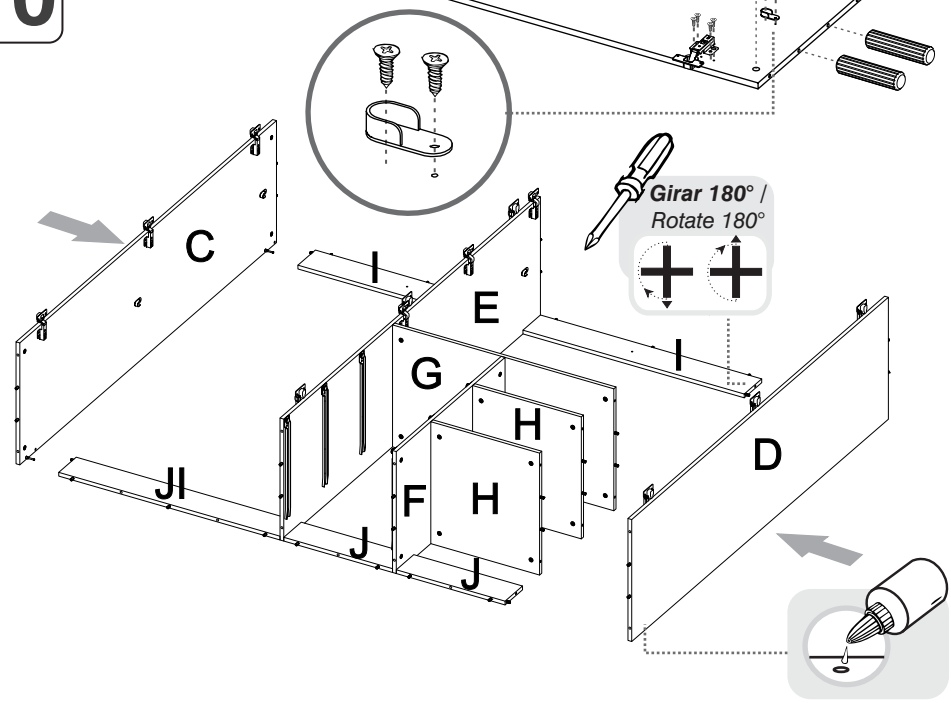

3

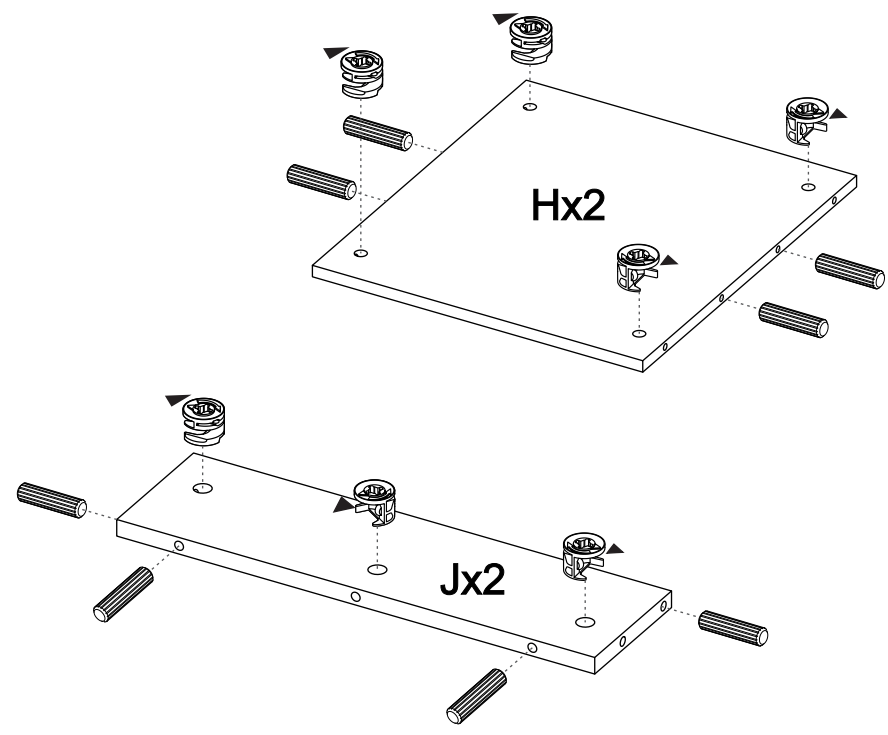

4

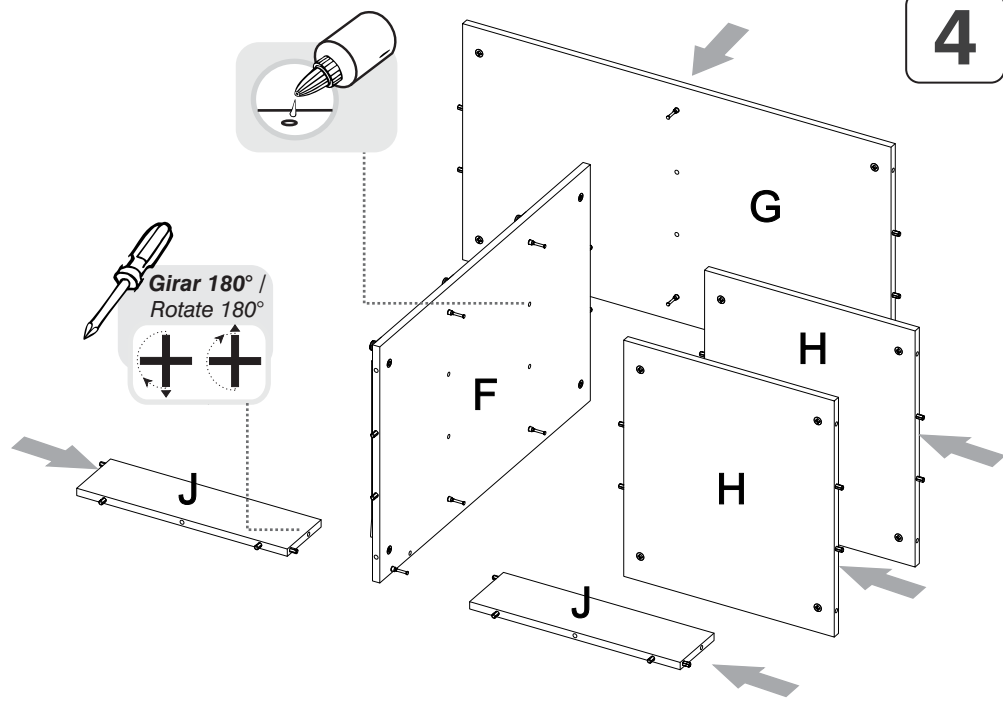

5

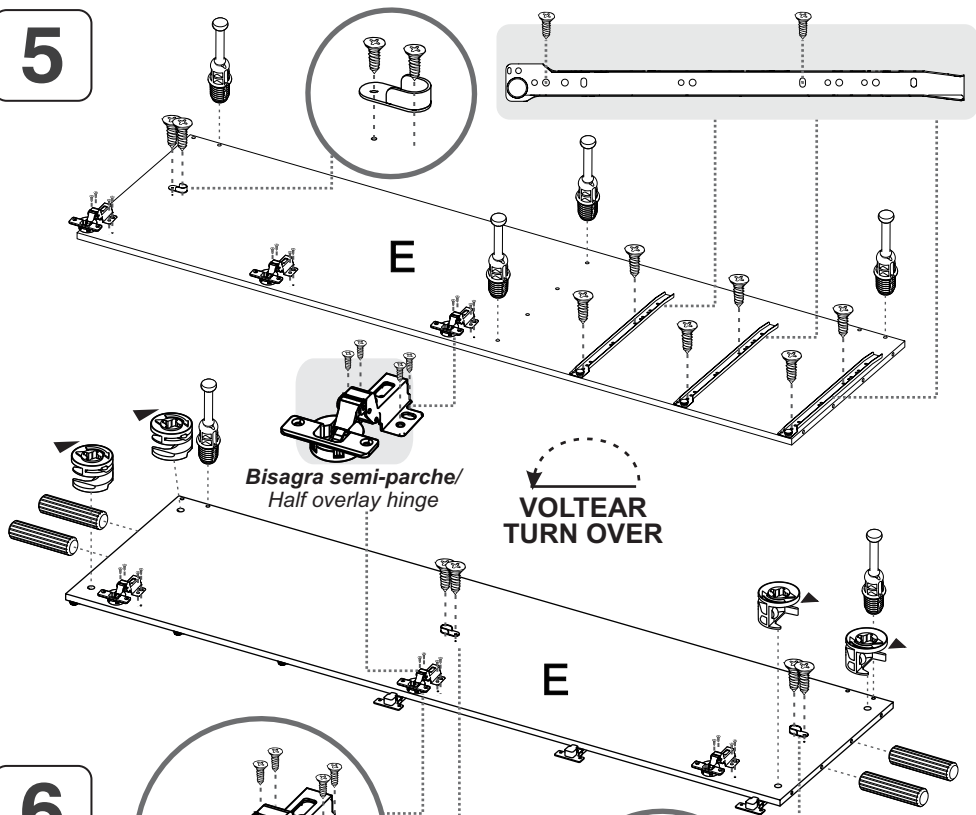

6

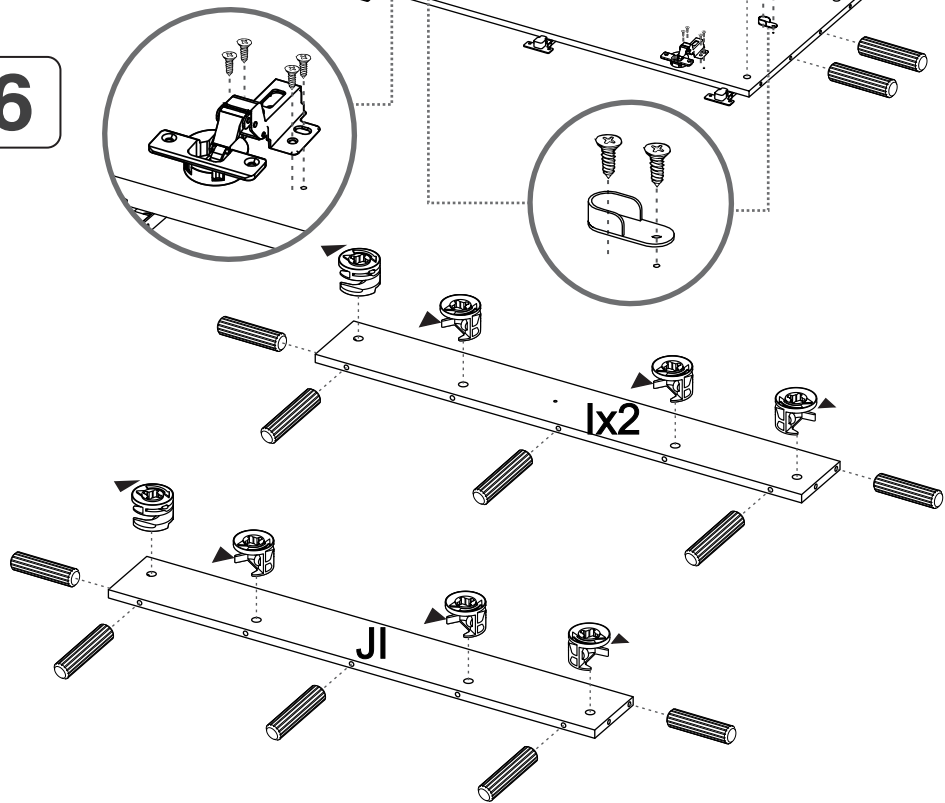

7

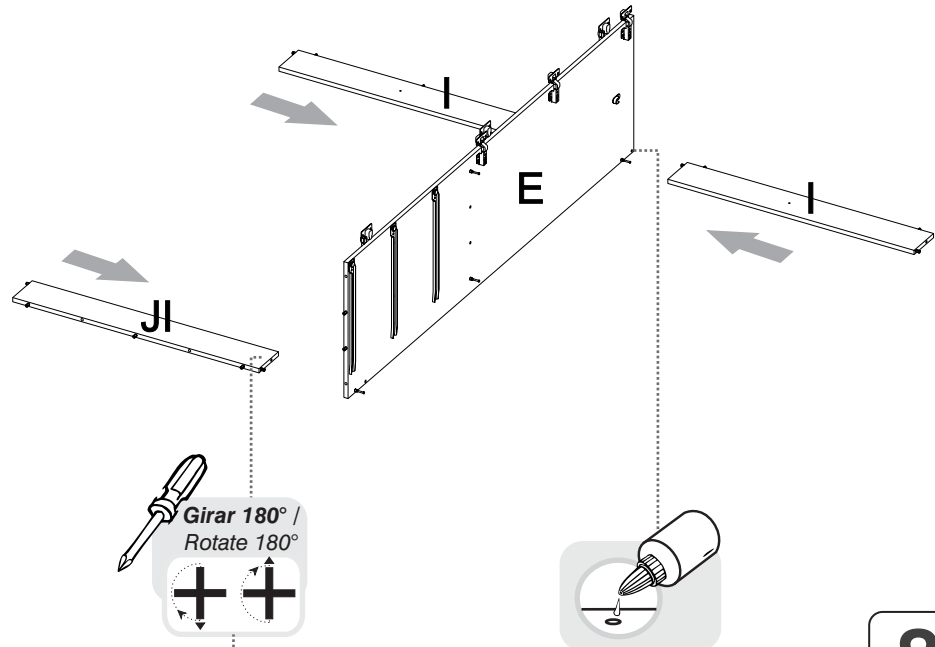

8

