

10

INSTALACIÓN BISAGRAS
HINGES INSTALLATION

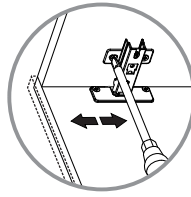

AJUSTE DE ALTURA
/ HEIGHT
ADJUSTMENT

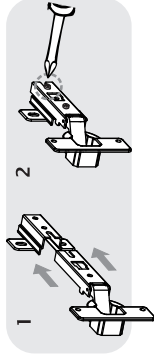
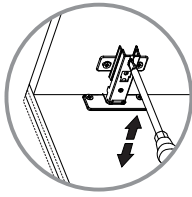

AJUSTE DE PROFUNDIDAD
/ DEPTH
ADJUSTMENT

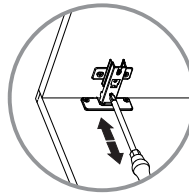

AJUSTE LATERAL
/ LATERAL
ADJUSTMENT

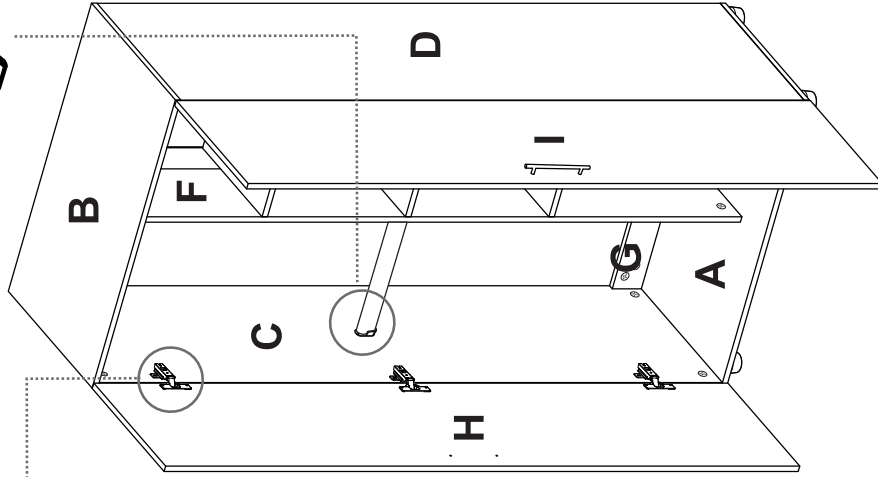
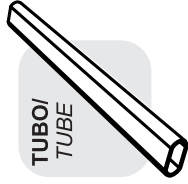

INSTRUCCIONES DE ENSAMBLE
ASSEMBLY INSTRUCTIONS

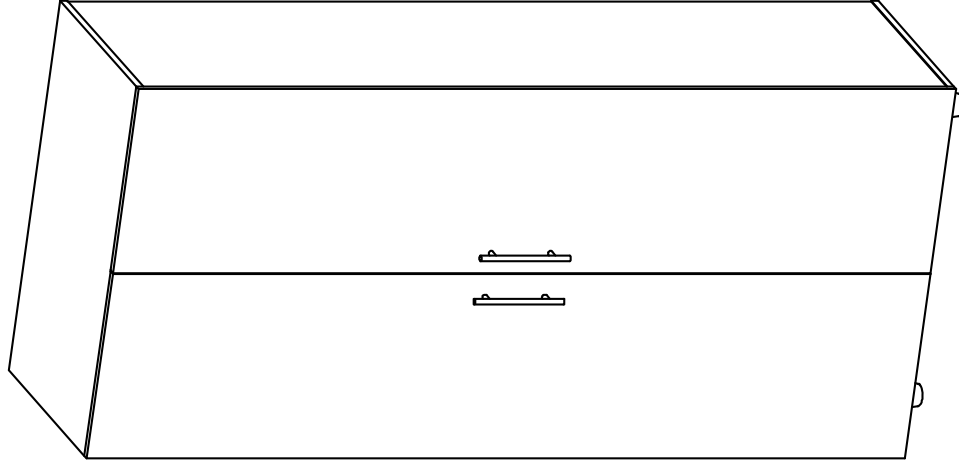

Alto/ Height: 180 cm / 70.9 in /
Ancho/ Width: 80 cm / 31.5 in /
Fondo/ Depth: 48 cm / 18.9 in

LOTE No: _____

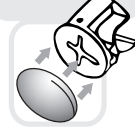

Al finalizar el ajuste, cubra las cajas con las tapas adhesivas/After tightening all the panels, cover the minifix-cams with the adhesive caps.



Al terminar de armar, despegue los adhesivos (en caso de que queden residuos de pegamento, limpie la superficie con alcohol) / After finishing the assembly, take off the adhesives. (In case of glue residues, wipe them with alcohol)

By: **RTA design**
RTA DESIGN S.A.S.
TEL (572) 691 17 00
PBX (572) 695 91 81
CALLI - COLOMBIA
www.rta.com.co

CLOSET TERA
/Tera Wardrobe

RECOMENDACIONES IMPORTANTES KEY RECOMMENDATIONS

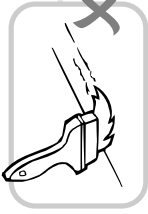

NO pinte el mueble /
Do not paint the
furniture.



NO mojar o ubicar
a la intemperie /
Do not expose to rain
or direct sun.

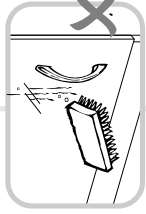
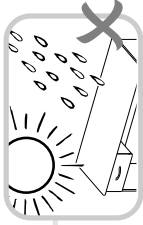

NO lavar las manijas o
tiraderas con jabones o
elementos abrasivos /
Do not wash handles
or dumbs with soap or
abrasives.

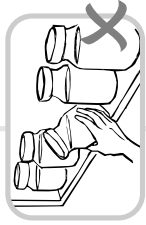

NO sobrecargue el mueble.
no exceda el peso de 30 kilos
para gabinetes de cocina /
Do not overload the cabinet.
Weight max. 66lbs
for kitchen cabinets.



NO golpear ni martillar
el mueble (hágalo sólo
donde se indique) /
Do not hit or hammer
the furniture (just do it
where is indicated).

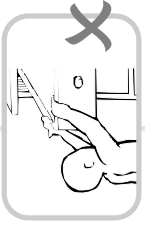

NO permita que los niños
manipulen el mueble, puede
voltearse y lastimarnos /
Do not allow children to
handle the cabinets or
drawers, they could get hurt.



SIEMPRE levante el
mueble entre dos
personas, NO lo arrastre /
Do not drag the furniture.
Lift it between two people.

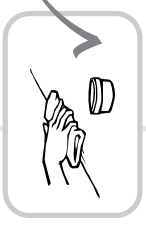

Limpie con paño seco.
/ Clean with a dry cloth.

HERRAJES BÁSICOS PARA MUEBLES RTA BASIC HARDWARE FOR RTA FURNITURE

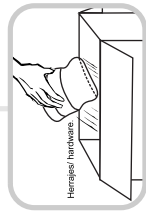

1. Abrir la caja del mueble
y buscar la bolsa con los
herrajes / Open the box
and look for the hardware
bag.

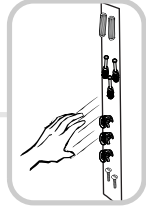

3. Separe los herrajes para
facilitar su identificación
durante el armado /
Separate hardware for easy
identification during
assembly.

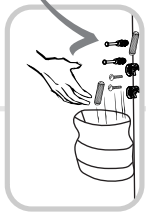

2. Abrir el paquete y
comprobar que el
contenido de las piezas es
correcto / Open the
package and verify that
the content of the pieces
is correct.

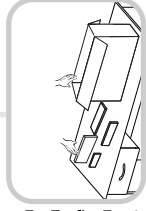

4. Arme el mueble en un
lugar limpio y en una
superficie plana / Assemble
the furniture in a clean
place and on a flat surface.



IMPORTANTE

Tenga en cuenta: Voltear el
mueble cuidadosamente para
ensamblar los fondos.

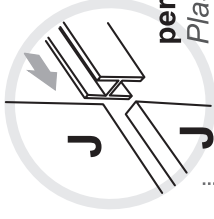

perfil en H/
Plastic guide

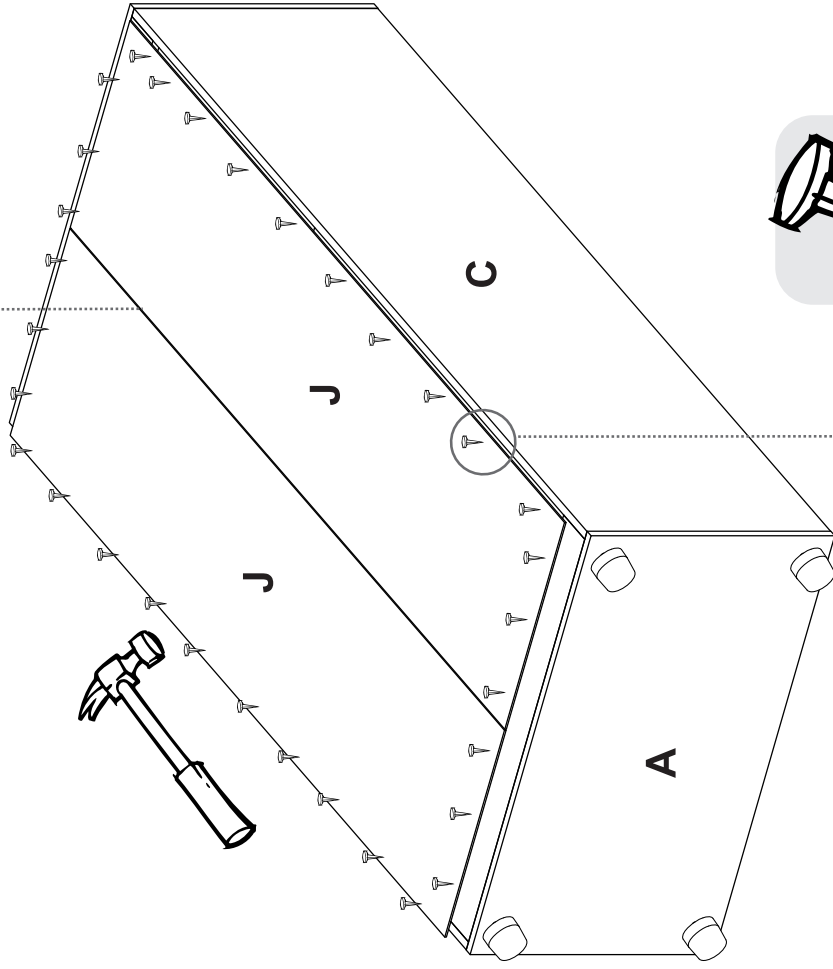

7

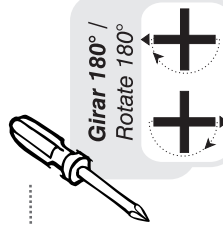
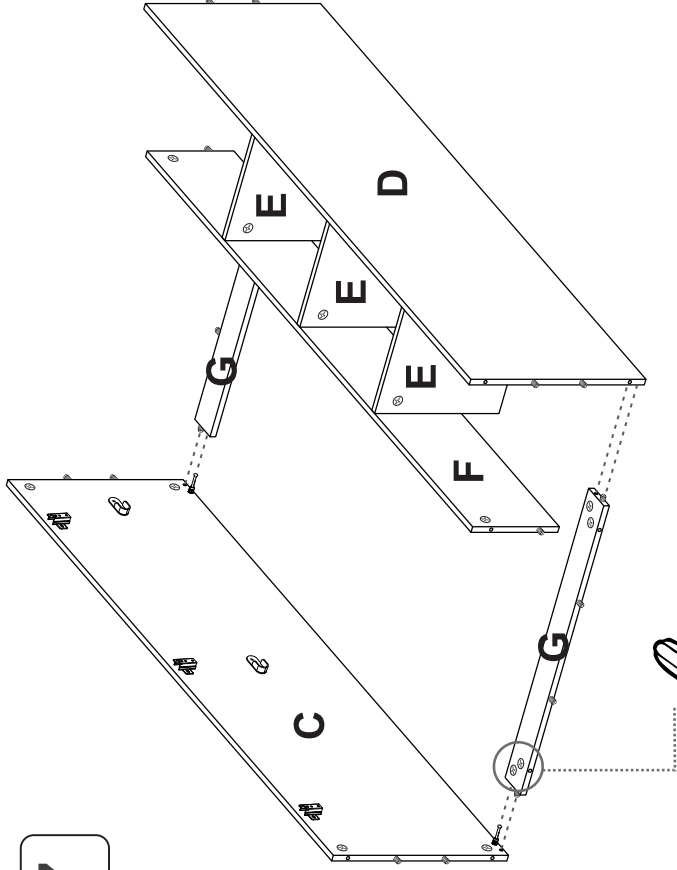

8

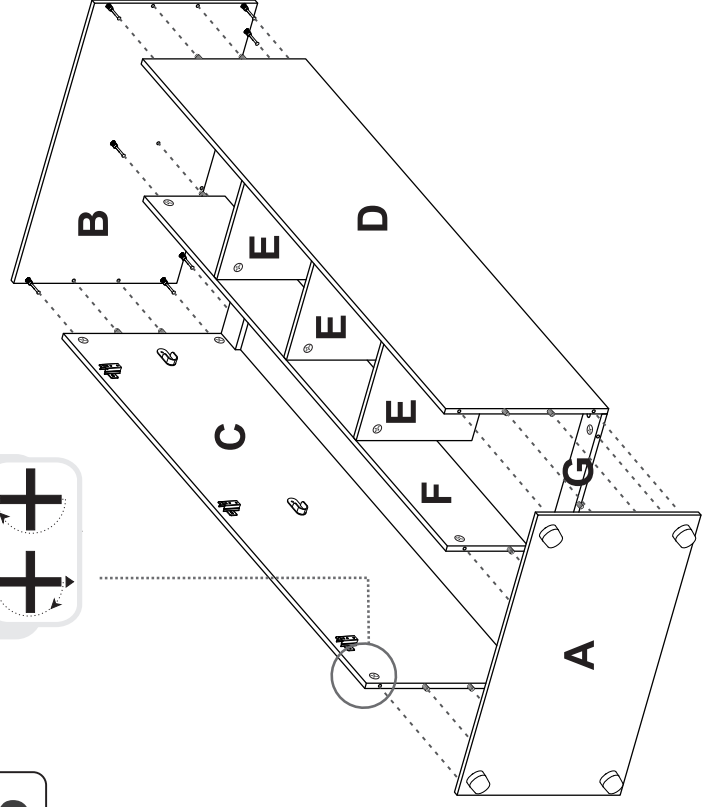

RECOMENDACIONES DE ENSAMBLE / ASSEMBLY RECOMMENDATIONS

El buen funcionamiento del mueble depende de un adecuado ensamblaje
An excellent furniture's performance relies on a solid and a suitable assembly.

MINIFIX / CONNECTOR - DOWELS

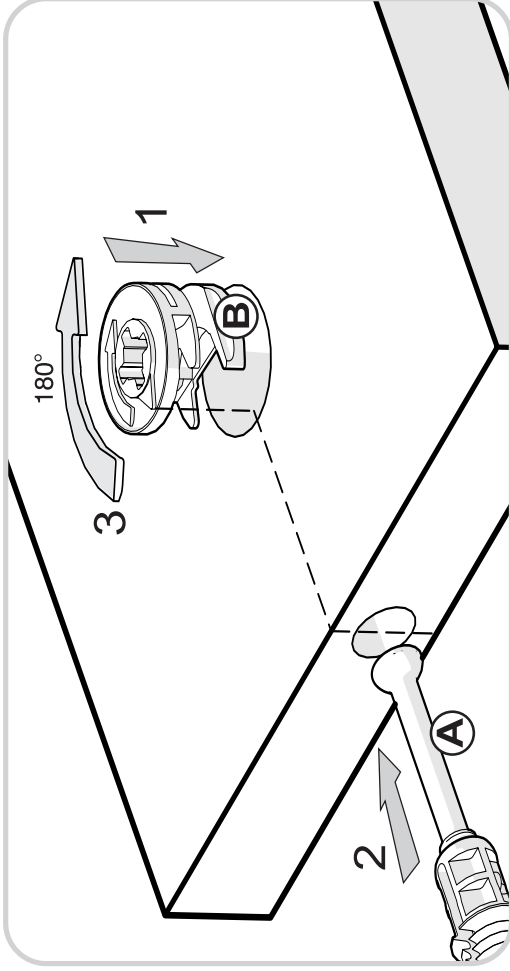

Sistema de unión compuesto por un perno (A) y una caja minifix (B).

(1) Se inserta la caja minifix dentro de la perforación ubicada en la cara de la pieza, la flecha debe apuntar siempre a la dirección de la perforación por donde entrará el perno.

(2) Se debe insertar el perno por su parte plástica en las perforaciones que se indiquen, luego se inserta la punta metálica en la perforación para que su cabeza quede al interior de la caja minifix.

(3) Girar la caja minifix 180° para apretar las dos piezas.

It's a fitting system made of a spreading bolt (A) and a minifix cam (B).

(1) Insert the minifix cam in the hole placed in the face of the panel with the arrow pointing towards the hole where the bolt will fit.

(2) Insert the bolt with its plastic base in the shown holes, then insert the metallic bolt head in the holes so it fits inside the minifix cam.

(3) Tight the panels by turning the minifix cam 180°.

TARUGOS O TAQUETES / FLUTED DOWEL PIN

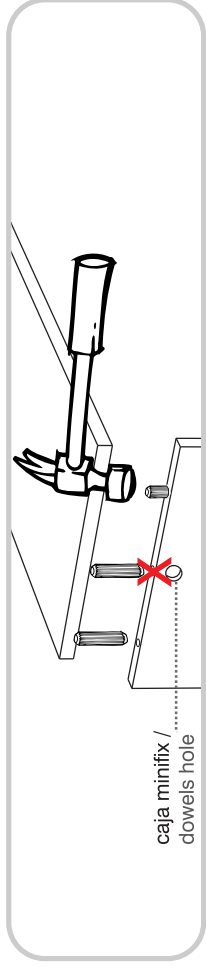









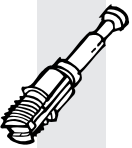

caja minifix /
dowels hole

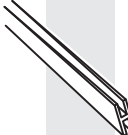
Es un pedazo de madera corto y grueso, de aproximadamente 5 a 10 cm de largo, que sirve para amarrar el mueble y darle resistencia.

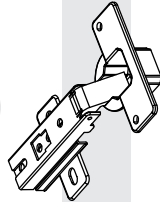
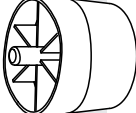
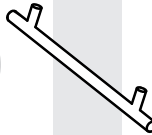
It's a short and thick piece of wood, 1,9 to 3,9 inches approximately, which is used to tie the cabinet and give it resistance.

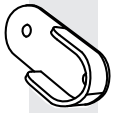
HERRAJES PARA ARMADO ASSEMBLY HARDWARE

	x24		x24		x27		x32		x24
Minifix/ Minifix Cams		Perno minifix/ Spreading Bolt		Tarugo/ Fluted Dowel Pin		Tornillo lamina/ Sheet Metal Screw		Tapa Adhesiva Minifix/ Cover Caps	
	x1		x32		x6		x4		
Perfil en H/ Plastic Guide 1565 mm		Puntillas/ Nails		Bisagra Parche 35mm/ Full Overlay Hinge		Deslizador Plástico 40mm/ Plastic Glide			
	x2		x4		x4		x2		
Manija Acero Inox/ Handle		Tornillo Manija 3/4"/ Handle Screw		Soporte Tubo Ovalado/ Rod Support		Tubo Ovalado/ Closet Rod			



TENER PRECAUCIÓN AL ABRIR LA BOLSA DE HERRAJES PARA NO EXTRAIAR NINGUNO. COMPRUEBE QUE EL CONTENIDO DE LAS PIEZAS SEA EL CORRECTO. EN CASO QUE FALTE ALGUNA PIEZA O ESTÉ DEFECTUOSA DEVUELVA LAS PIEZAS AL ALMACÉN CON SU FACTURA PARA EFECTUAR EL CAMBIO DE LAS PIEZAS Y/O LOS HERRAJES LO MÁS PRONTO POSIBLE./ PLEASE BE CAUTIOUS WHEN OPENING THE HARDWARE BAG TO NOT LOSE ANY. CHECK THE CONTENTS OF THE PARTS ARE CORRECT. IF ANY PART IS MISSING OR IMPERFECT PLEASE RETURN THE PARTS TO THE STORE WITH THE PRODUCT INVOICE ATTACHED TO MAKE EFFECTIVE THE REPLACEMENT OF THE IMPERFECT PIECES OR HARDWARE AS SOON AS POSSIBLE.

5

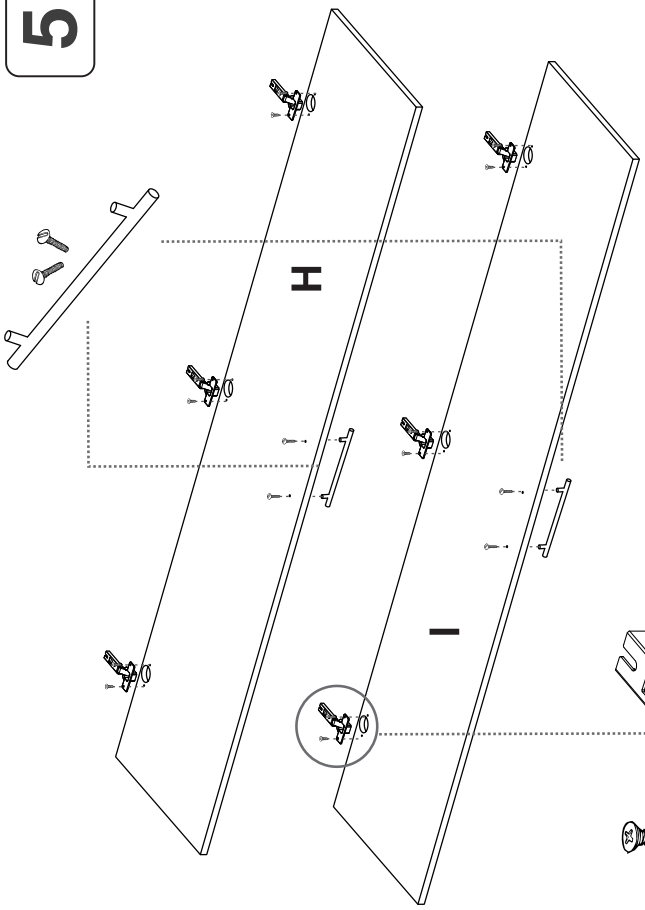

6

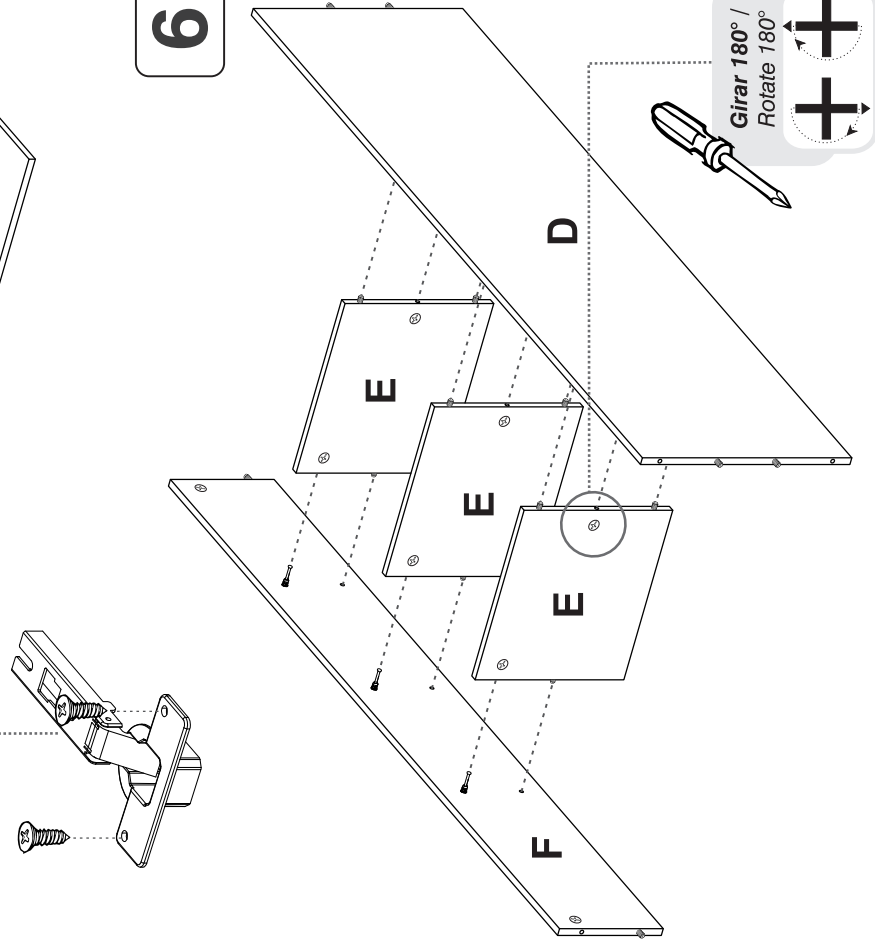

Girar 180° /
Rotate 180°

**PIEZAS DE ARMADO
ASSEMBLY PARTS**

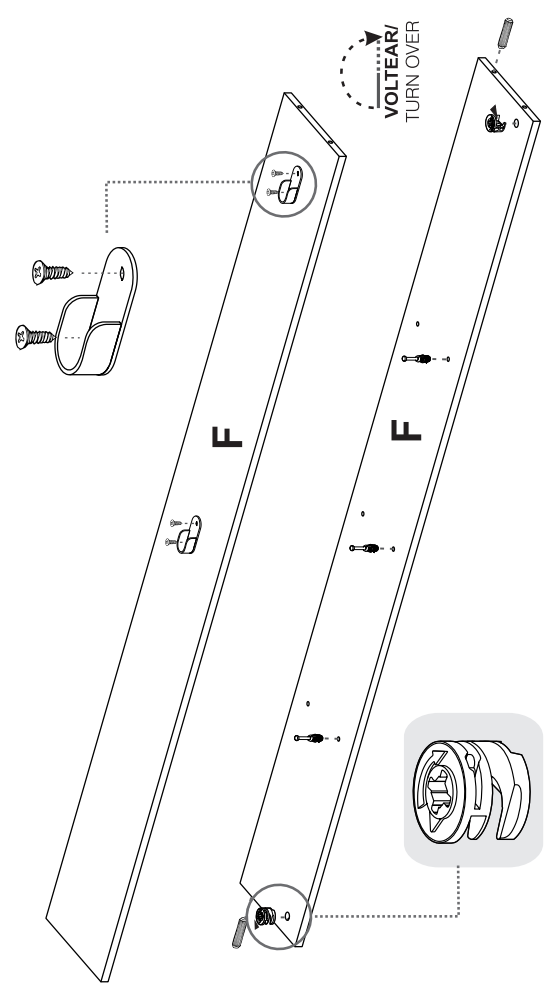
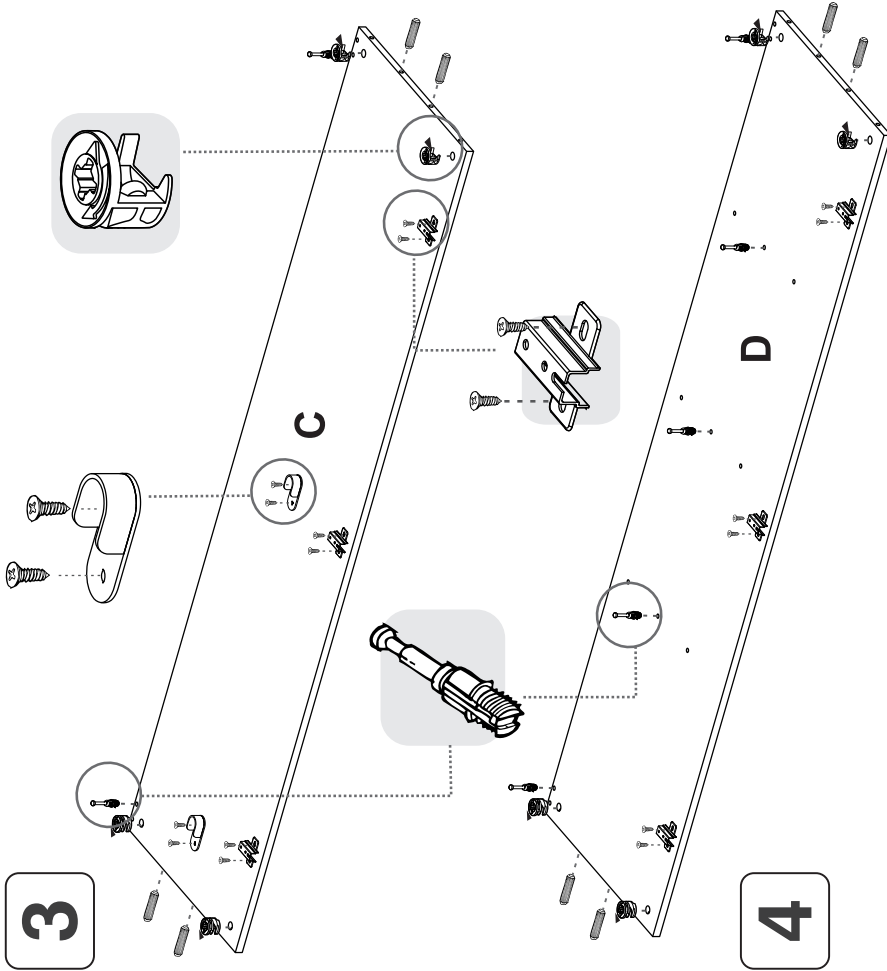
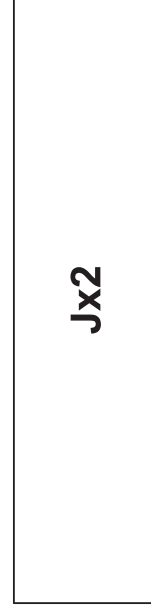
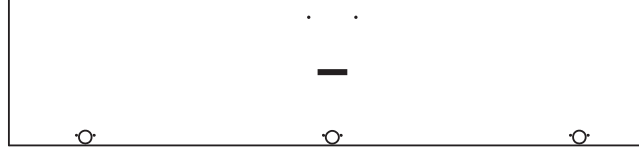
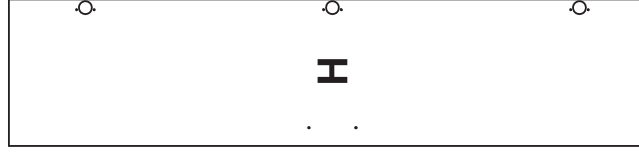
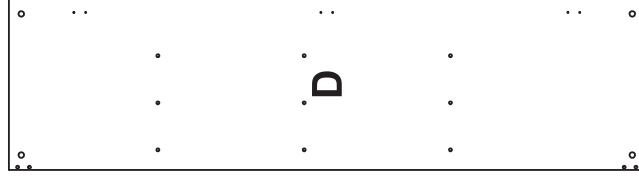
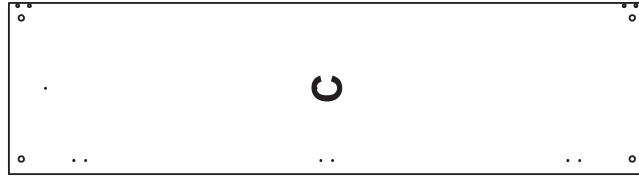
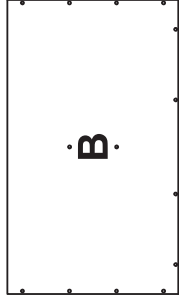
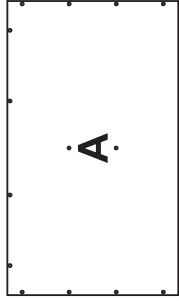

**VOLTEAR!
TURN OVER**



ANTES DE EMPEZAR A ARMAR EL MUEBLE LEA DETENIDAMENTE LAS INSTRUCCIONES. SE RECOMIENDA ARMAR EL MUEBLE SOBRE LA CAJA O SOBRE UNA SUPERFICIE LISA Y CUBIERTA. PARA NO RAYARLO / BEFORE STARTING TO ASSEMBLE THE FURNITURE, CAREFULLY READ THE INSTRUCTIONS. IT IS RECOMMENDED TO ASSEMBLE THE FURNITURE ON THE BOX OR ON A FLAT AND COVERED SURFACE IN ORDER TO NOT SCRATCH THE PRODUCT.

1

SE RECOMIENDA ARMAR EL MUEBLE ENTRE DOS PERSONAS / IT IS RECOMMENDED TO ASSEMBLE THE PRODUCT BETWEEN TWO PEOPLE

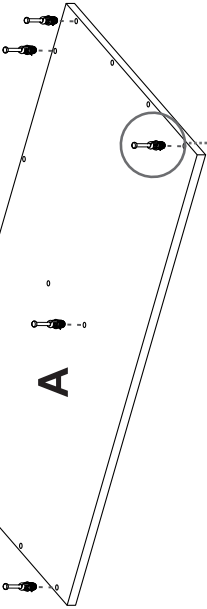
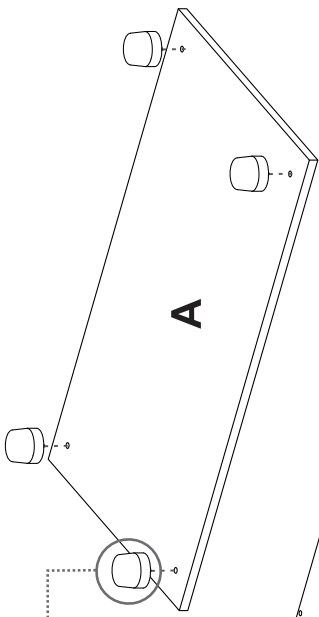
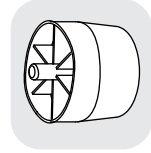

VOLTEAR/
TURN OVER

2

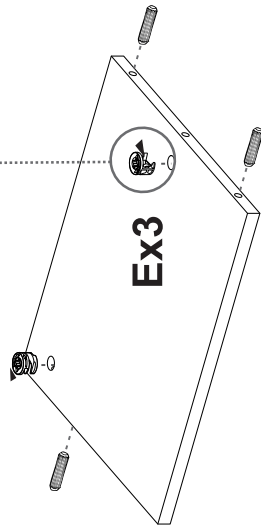
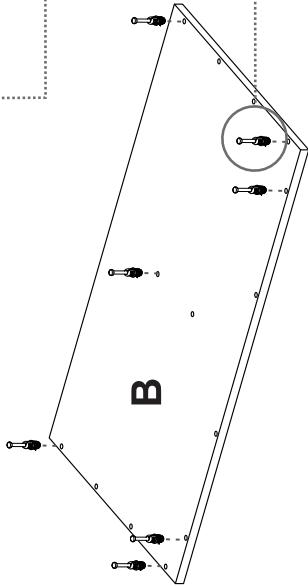
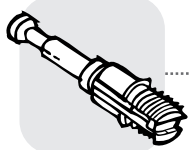

Ex3

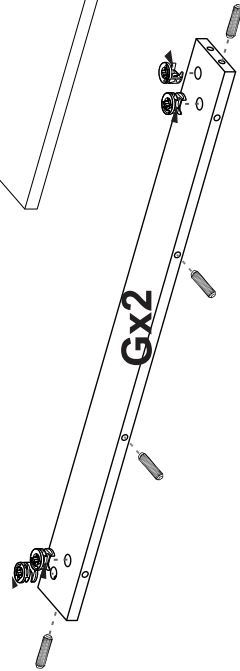

Gx2

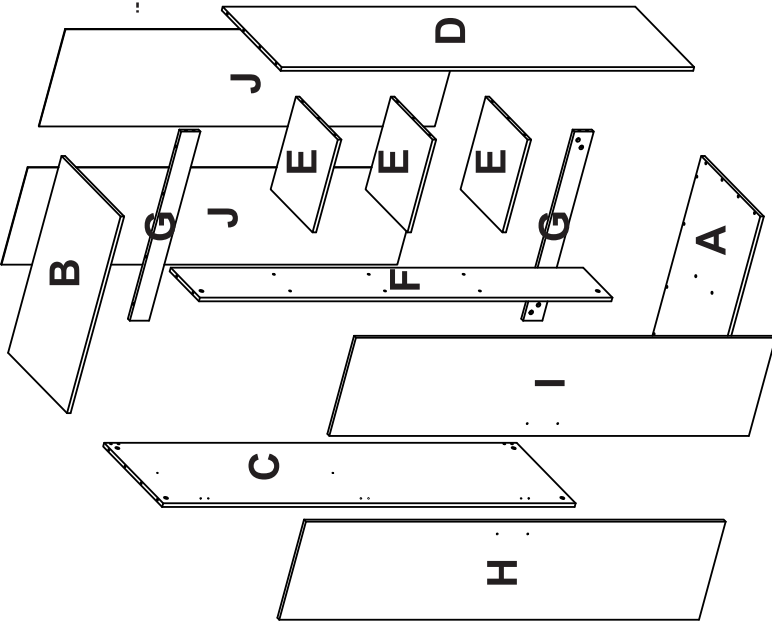

*(Herramientas NO incluidas)

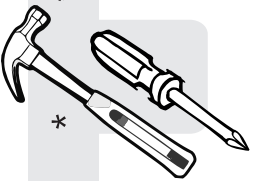

*